

thecarversite.com

This manual is either an original scan from tech's who worked at Carver corp, donated by forum members, or both. These manuals are NOT intended for re-sale. If you purchased a 'Carver Manuals' disc on ebay or another auction site, and it has this material on it, you were ripped off!

Please report any resale of this material to us at thecarversite.com

thecarversite.com

CARVER

TFM-55
Simultaneous High Voltage/High Current
Magnetic Field Power Amplifier

Owner's Manual

CARVER

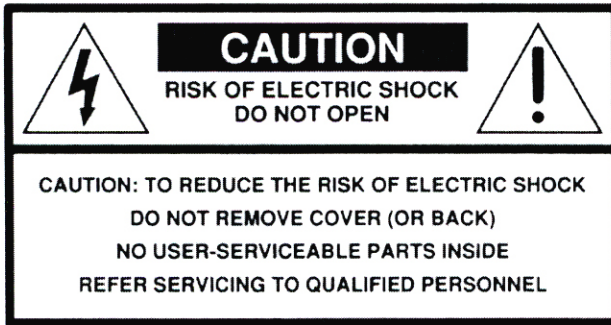

Safety Instructions

1. Read Instructions—All the safety and operation instructions should be read before the Carver Component is operated.
2. Retain Instructions—The safety and operating instructions should be kept for future reference.
3. Heed Warnings—All warnings on the Component and in these operating instructions should be followed.
4. Follow Instructions—All operating and other instructions should be followed.
5. Water and Moisture—The Component should not be used near water—for example, near a bath-tub, washbowl, kitchen sink, laundry tub, in a wet basement, or near a swimming pool, etc.
6. Ventilation—The Component should be situated so that its location or position does not interfere with its proper ventilation. For example, the Component should not be situated on a bed, sofa, rug, or similar surface that may block any ventilation openings; or placed in a built-in installation such as a bookcase or cabinet that may impede the flow of air through ventilation openings.
7. Heat—The Component should be situated away from heat sources such as radiators, or other devices which produce heat.
8. Power Sources—The Component should be connected to a power supply only of the type described in these operation instructions or as marked on the Component.
9. Power Cord Protection—Power-supply cords should be routed so that they are not likely to be walked upon or pinched by items placed upon or against them, paying particular attention to cords at plugs, convenience receptacles, and the point where they exit the Component.



The lightning flash with arrowhead symbol within an equilateral triangle is intended to alert the user to the presence of uninsulated "dangerous voltage" within the product's enclosure, that may be of sufficient magnitude to constitute a risk of electric shock to persons.



The exclamation point within an equilateral triangle is intended to alert the user of the presence of important operating and maintenance (servicing) instructions in the literature accompanying the appliance.

10. Cleaning—The Component should be cleaned only as recommended in this manual.
11. Non-use Periods—The power cord of the Component should be unplugged from the outlet when unused for a long period of time.
12. Object and Liquid Entry—Care should be taken so that objects do not fall into and liquids are not spilled into the inside of the Component.
13. Damage Requiring Service—The Component should be serviced only by qualified service personnel when:
 - A. The power-supply cord or the plug has been damaged; or
 - B. Objects have fallen, or liquid has spilled into the Component; or
 - C. The Component has been exposed to rain; or
 - D. The Component does not appear to operate normally or exhibits a marked change in performance; or
 - E. The Component has been dropped, or its cabinet damaged.

PORTABLE CART WARNING



Carts and stands—The Component should be used only with a cart or stand that is recommended by the manufacturer. A Component and cart combination should be moved with care. Quick stops, excessive force, and uneven surfaces may cause the Component and cart combination to overturn.

14. Servicing—The user should not attempt to service the Component beyond those means described in this operating manual. All other servicing should be referred to qualified service personnel.

15. To prevent electric shock, do not use this polarized plug with an extension cord, receptacle or other outlet unless the blades can be fully inserted to prevent blade exposure.

Pour prévenir les chocs électriques ne pas utiliser cette fiche polarisée avec un prolongateur, un prise de courant ou une autre sortie de courant, sauf si les lames peuvent être insérées à fond sans laisser aucune partie à découvert.

16. Grounding or Polarization—Precautions should be taken so that the grounding or polarization means of the Component is not defeated.

17. Internal/External Voltage Selectors—Internal or external line voltage selector switches, if any, should only be reset and re-equipped with a proper plug for alternate voltage by a qualified service technician. See an Authorized Carver Dealer for more information.

18. Attachment Plugs for Alternate Line Voltage (Dual voltage models only)— See your Authorized Carver Dealer for information on the attachment plug for alternate voltage use. This pertains to dual-voltage units only.

This apparatus does not exceed the Class A/Class B (whichever is applicable) limits for radio noise emissions from digital apparatus as set out in the radio interference regulations of the Canadian Department of Communications.

ATTENTION—Le présent appareil numérique n'émet pas de bruits radioélectriques dépassant les limites applicables aux appareils numériques de class A/de class B (selon le cas) prescrites dans le règlement sur le brouillage radioélectrique édicté par les ministere des communications du Canada.

WARNING – To reduce the risk of fire or electric shock, do not expose this appliance to rain or moisture.

Contents

Safety Instructions	Page 2
A Message from Bob Carver	Page 4
Unpacking	Page 4
Specifications and Features	Page 5
Installation	Page 6
Operation	Page 12
Troubleshooting Guide	Page 14
Care and Service Assistance	Page 15

A Message From Bob Carver

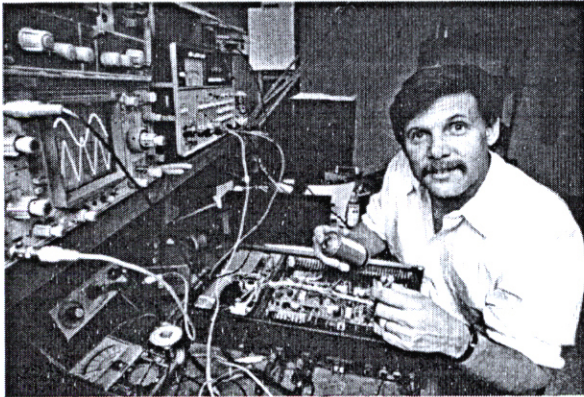

Dear Customer,

Thank you for choosing Carver electronics. We at Carver Corporation realize that there is an abundance of home electronics from which to choose, and the differences between the various models are not always apparent at first glance. Carver Corporation strives to produce for you the finest in audio reproduction equipment by integrating the latest and best technology with the most competitive price possible.

The TFM-55 incorporates Carver's exclusive Magnetic Field Amplifier technology, which makes it capable of higher simultaneous current and voltage than any other design in its price range. Judged against other amplifier standards, it is second to none. Its sound quality is smooth, sweet and absolutely dynamically accurate. With both channels driven, it can deliver up to 380 watts per channel into 8 ohms with less than 0.5% THD.

As an added benefit, the TFM-55 is Transfer Function Calibrated to closely match the sonic signature of our ultra-high-end Silver Seven Vacuum Tube Reference Amplifier. This assures you of truly state-of-the-art performance.

The TFM-55 is a fine example of our commitment to excellence. We believe its sophisticated engineering and meticulous craftsmanship will provide you with many years of listening pleasure.

Sincerely,

Bob Carver

Unpacking

Upon opening the box, please check for any damage that does not appear on the outside of the box. If you do encounter what appears to be concealed damage, please consult your Dealer before proceeding to further unpack the unit.

If no damage is found, gently lift the amplifier out of the box, and remove the molded side packing material.

Please save the box, as well as all of the internal packing materials! This container is the best way to store and move your new amplifier. If your amplifier should need repair, the original container is ideal for shipping to a Carver Service Center.

Make a note of the serial number which is located on the back of your amplifier. Record it in the space provided in this manual for convenient reference. You will need to refer to this number if you need service or if your unit is (perish the thought) stolen.

Model: **TFM-55**

Serial number _____

Purchased at _____

Date _____

Make sure to save your sales receipt. It is extremely important in establishing the duration of your Limited Warranty and for insurance purposes.

Finally, take a moment to fill out and return the Warranty Card that came with the amplifier and return it to Carver.

Specifications & Features

Specifications

Power Output:

Continuous Average Power Output
(both channels driven):

380 watts RMS per channel into 8 ohms
from 20 Hz to 20 kHz, with no more than
0.5% THD

500 watts RMS per channel into 4 ohms
from 20 Hz to 20 kHz, with no more than
0.5% THD

Bridged Mono Operation:

1000 watts RMS into 8 ohms from 20 Hz to
20 kHz, with no more than 0.5% THD

Input impedance:

47 K ohms

Sensitivity:

1.5 V RMS for rated 8 ohm power

Gain:

31 dB

Signal to Noise Ratio:

100dB A-weighted, referenced to rated power

Power Requirements:

120 V/60Hz, 12 Amps, USA: other voltages
available as export models

Dimensions:

4.7"H x 19"W x 14.3"D

119mm x 483mm x 363mm

Net Weight:

23 lbs (10.43 kgs.)

Shipping Weight:

25 lbs (12.7 kgs.)

Features

- 380 watts per channel into 8 ohms;
500 watts per channel into 4 ohms.
- Switchable bridged mono operation
provides 1000 watts at 8 ohms.
- Exclusive Carver Magnetic Field Power
Supply provides simultaneous high volt-
age and high current in a unit that is
smaller and much more efficient than
conventional amplifier designs.
- Transfer Function Calibrated to closely
replicate the sonically pure characteristics
of our ultra-high-end Carver Silver Seven
Vacuum Tube Reference Amplifier.
- Illuminated dual-range analog meters.
- Meter dimmer switch.
- Input level controls.

Specifications & Features

Specifications

Power Output:

Continuous Average Power Output
(both channels driven):

380 watts RMS per channel into 8 ohms
from 20 Hz to 20 kHz, with no more than
0.5% THD

500 watts RMS per channel into 4 ohms
from 20 Hz to 20 kHz, with no more than
0.5% THD

Bridged Mono Operation:

1000 watts RMS into 8 ohms from 20 Hz to
20 kHz, with no more than 0.5% THD

Input impedance:

47 K ohms

Sensitivity:

1.5 V RMS for rated 8 ohm power

Gain:

31 dB

Signal to Noise Ratio:

100dB A-weighted, referenced to rated power

Power Requirements:

120 V/60Hz, 12 Amps, USA: other voltages
available as export models

Dimensions:

4.7"H x 19"W x 14.3"D

119mm x 483mm x 363mm

Net Weight:

23 lbs (10.43 kgs.)

Shipping Weight:

25 lbs (12.7 kgs.)

Features

- 380 watts per channel into 8 ohms;
500 watts per channel into 4 ohms.
- Switchable bridged mono operation
provides 1000 watts at 8 ohms.
- Exclusive Carver Magnetic Field Power
Supply provides simultaneous high volt-
age and high current in a unit that is
smaller and much more efficient than
conventional amplifier designs.
- Transfer Function Calibrated to closely
replicate the sonically pure characteristics
of our ultra-high-end Carver Silver Seven
Vacuum Tube Reference Amplifier.
- Illuminated dual-range analog meters.
- Meter dimmer switch.
- Input level controls.

Installation

Rear Panel

- 1. STEREO/MONO SWITCH.** For normal stereo operation, this switch should remain in the STEREO POSITION. By switching it to the MONO position, you may use the TFM-55 as a 1000 watt (at 8 ohms) mono amplifier. Be sure to follow the special directions provided on page 8 for mono operation.
- 2. LINE LEVEL INPUTS.** You may attach virtually any quality preamplifier to the TFM-55.
- 3. SPEAKER TERMINALS.** These multi-way binding posts are designed for banana plugs or direct wire connections. Please check the Speaker Connection instructions on page 8 of this manual for information on cable selection and connection to your loudspeakers.

Note: The output of the TFM-55 can develop hazardous voltages. Care should be taken in connecting the speakers to prevent electric shock or damage to the amplifier. Turn the TFM-55 OFF before making any change to speaker wiring or when connecting the unit to another component.

Amplifier Placement

The amplifier can be positioned as part of a "stack" of components if some care is taken. Because the TFM-55 is convection-cooled it requires clearance for air to reach the ventilation slots on the top, bottom and side of the unit.

Do **NOT** place the amplifier on carpeting or any surface that might tend to block its ventilation slots from air circulation.

The TFM-55 can be placed in an equipment rack which has adequate ventilation. If your shelves do not have open backs, make sure there are vent holes in them. The situation you want to avoid is placing your power amplifier in a sealed cubbyhole. That creates a static air space where temperatures can rise

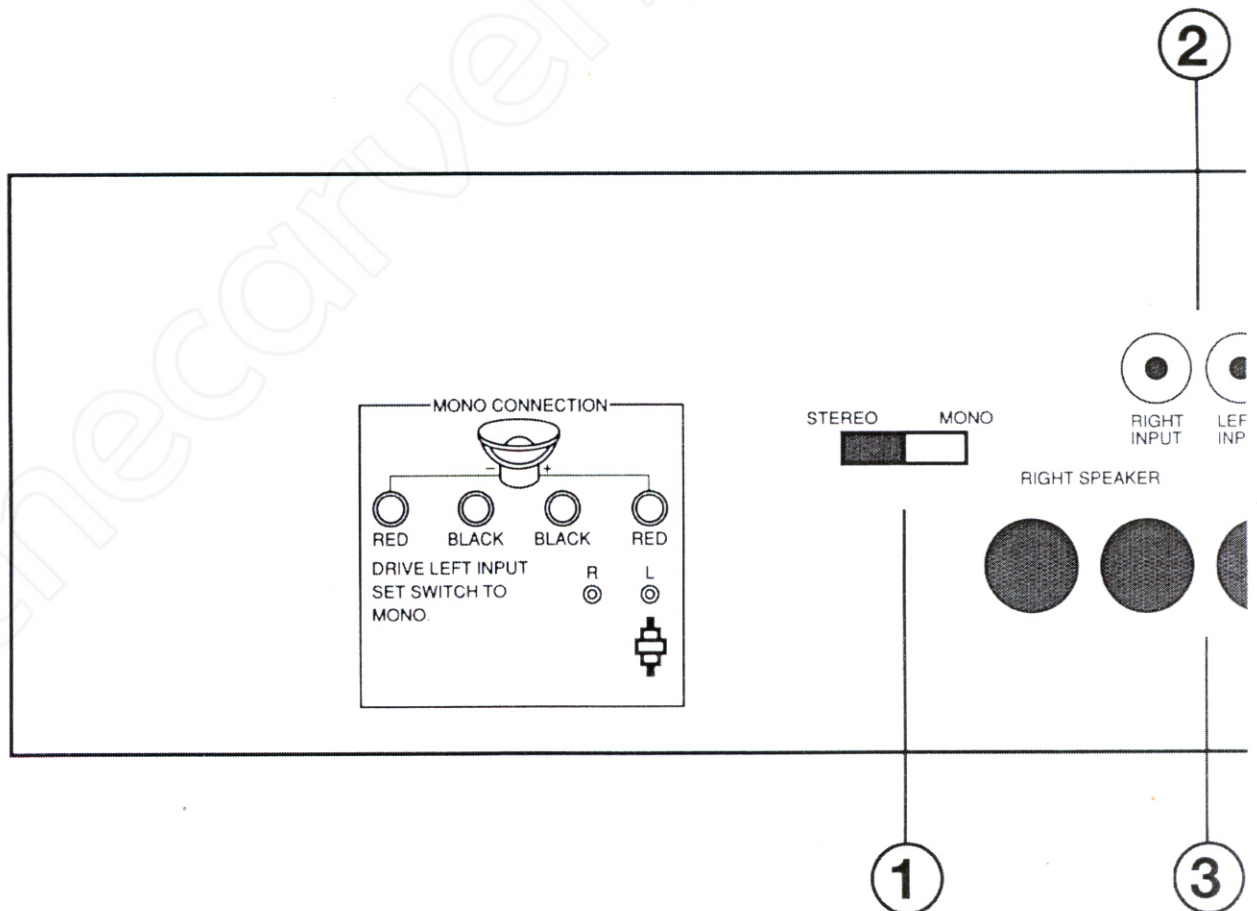

quickly. Do not place other components directly on top of the TFM-55.

Connection Tips

- Turn all other components **OFF** before making any connections.
- Make sure that “left is hooked to left and right is hooked to right” at each connection. The obvious way to assure this is to assign one hook-up cord plug color to left and the other to right. Generally **RED** is used to signify **RIGHT**. White, grey or black then represents left.
- Whenever possible, keep power cords away from signal cables to prevent hum. This is especially important for phono cables which carry very weak signals. The power cords and convenience outlets of Carver components are on the right side of the chassis (when viewed from the back). This allows you to bundle all the power cords and keep them separate from signal connections.

- **Hook-up Cables.** Make sure that the RCA-type cables you use are in good condition. The connectors on these cables must fit snugly in the jacks, particularly on the outside (ground) part. Always insert and remove cables by grasping the connector body, not the cable.

Amp-to-preamp connection—stereo operation

The TFM-55 is designed to be compatible with virtually any quality preamplifier, preamplifier/tuner or surround sound processor. See the diagrams on suggested hook-ups beginning on page 10.

1. Make sure that the TFM-55 is turned off.
2. Turn the input level controls on the TFM-55 to the minimum position (fully counterclockwise).
3. Use standard audio cables to connect the **RIGHT** and **LEFT CHANNEL** inputs on the rear panel of the TFM-55 to the **RIGHT** and **LEFT CHANNEL** outputs of the preamplifier. It might help to

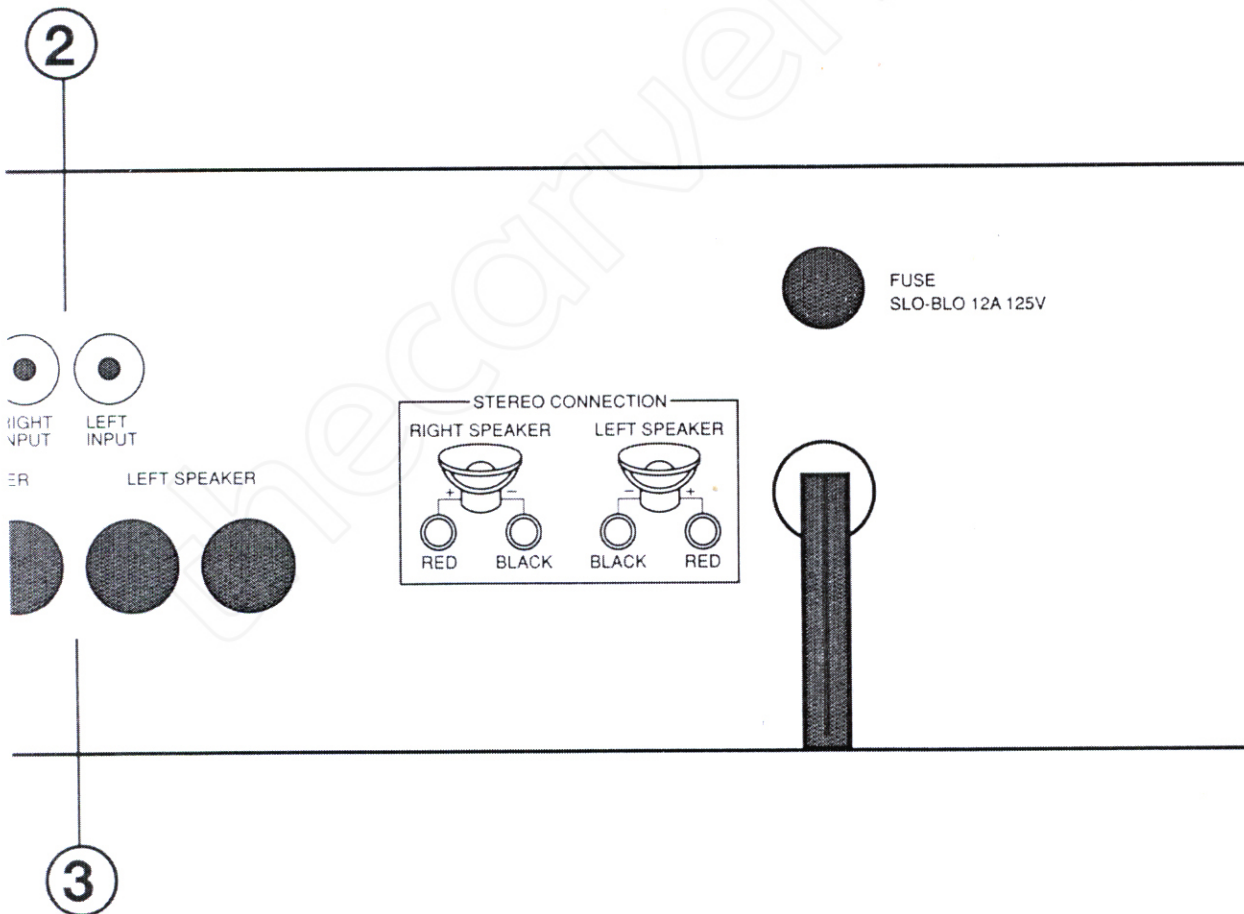

refer to the Owner's Manual for your other components at this point. System hook-up variations are shown in the diagrams beginning on page 10.

Speaker connections—stereo operation

WIRE. Use thick wire for speaker connections. Your Carver dealer can recommend a brand of high quality speaker cable. Please take care in choosing a cable of the right gauge. This will depend on the distance from the TFM-55 to your speakers. Use the following chart as a guide:

WIRE LENGTH GAUGE OF SPEAKER CABLE

Up to 25 ft	18 gauge
25 to 50 ft	16 gauge
50 to 80 ft	14 gauge
80 to 100 ft	12 gauge
Up to 170 ft	10 gauge

POLARITY. Loudspeakers must be connected with consistent polarity for correct phasing between them. Incorrect phasing will do no physical harm, but bass response will be diminished. The key is to make sure that both speakers connected to the speaker terminals are hooked up the same way:

"-" at the TFM-55 speaker outputs to "-" on the speaker back, and "+" at the TFM-55 speaker outputs to "+" on the speaker back.

If you're using special speaker interconnects, "+" and "-" will be labeled. If you're using plain appliance-type cable, the two conductors will be identified in one of several ways. They may be different colors (silver vs. gold). One may have fine grooves on its outside. Or one may have a piece of yarn included in one of the conductors (visible after you strip off the insulation). It doesn't matter which one you decide to call "+" or "-", just do the same for both speakers.

Hook-up. There are two ways to connect your loudspeakers to the binding post speaker terminals on the TFM-55. These binding posts will accept standard single or double banana plugs. These plugs can be attached to the end of the speaker cable, and plugged directly into the TFM-55's binding

post sockets. This makes connecting and disconnecting speakers simple and quick.

However, if you expect to hook-up your loudspeakers once and keep them connected that way, you may also attach the speaker cable in the following way:

1. Strip ½" of insulation off each wire and make sure to carefully twist all the fine strands together. If even one is loose and can touch the opposite terminal, a short circuit may result.
2. Unscrew the binding post and insert the wire so that all the strands will fit under the insulating cap of the binding post.
3. Follow the diagram on the rear panel of the TFM-55, matching polarities shown as positive (+) and negative (-) with the polarities shown on your loudspeakers.
4. Tighten the cap securely. Check to make sure that all strands of wire are inside the connection.
5. After you've hooked up the speakers, double-check your connections.
(**Note:** We have provided diagrams on suggested installations in the section beginning on page 10.)

Connections—mono operation

The TFM-55 will provide 1000 watts of power into 8 ohms when used in mono (bridged) mode. Turn to page 11 for a suggested hook-up illustration. To operate the TFM-55 as a mono amplifier:

1. Follow the steps in the previous section in preparing cable for connection to the TFM-55.
2. Slide the STEREO/MONO switch located on the rear panel to "MONO."
3. Connect one output from the preamplifier to the LEFT input of the TFM-55. DO NOT connect anything to the TFM-55's RIGHT input during mono operation!
4. The speaker leads for ONE CHANNEL ONLY must be connected to the RED TERMINALS of the TFM-55. The black terminals must remain unconnected! Attach the positive (+) speaker connection to the red LEFT SPEAKER binding

post. The negative (–) wire is to be attached to the red RIGHT SPEAKER binding post. Use speakers with a rating of 8 ohms or more for mono operation.

5. If you are using two power amplifiers in mono to create stereo, repeat these steps for hooking up the other channel.

Amp-to-wall-socket connection

The TFM-55 may be plugged into a wall outlet or properly rated preamplifier convenience outlet (rated at 1500W or greater). Note that one line plug prong (spade) is slightly wider than the other and will only insert one way into an outlet. Make sure this polarity is maintained.

Amplifier Protection

The TFM-55 incorporates an AC line fuse along with specifically designed protection circuits to protect the amplifier and loudspeakers.

- The TFM-55's fault monitoring circuitry will protect the unit from short circuits, abnormal loads and overheating.
- The TFM-55's muting relays will protect your loudspeakers in case of the failure of a component or DC offset condition.
- The TFM-55 contains an AC power fuse that protects it in case of a major component failure.

Warning: NEVER replace or check the fuse while the TFM-55 is connected to an AC outlet. Be sure the amplifier is turned off AND unplugged before removing the fuse. If you replace the fuse, be sure you install a fuse of the same type and rating.

Speaker Protection

Note: If you are using speakers that do not have a power rating high enough to match the maximum power produced by the TFM-55, we recommend that you install speaker fuses. Use the fuse value recommended by the speaker manufacturer.

**Suggested Hook-Up #1
Basic Stereo (2 Channels)**

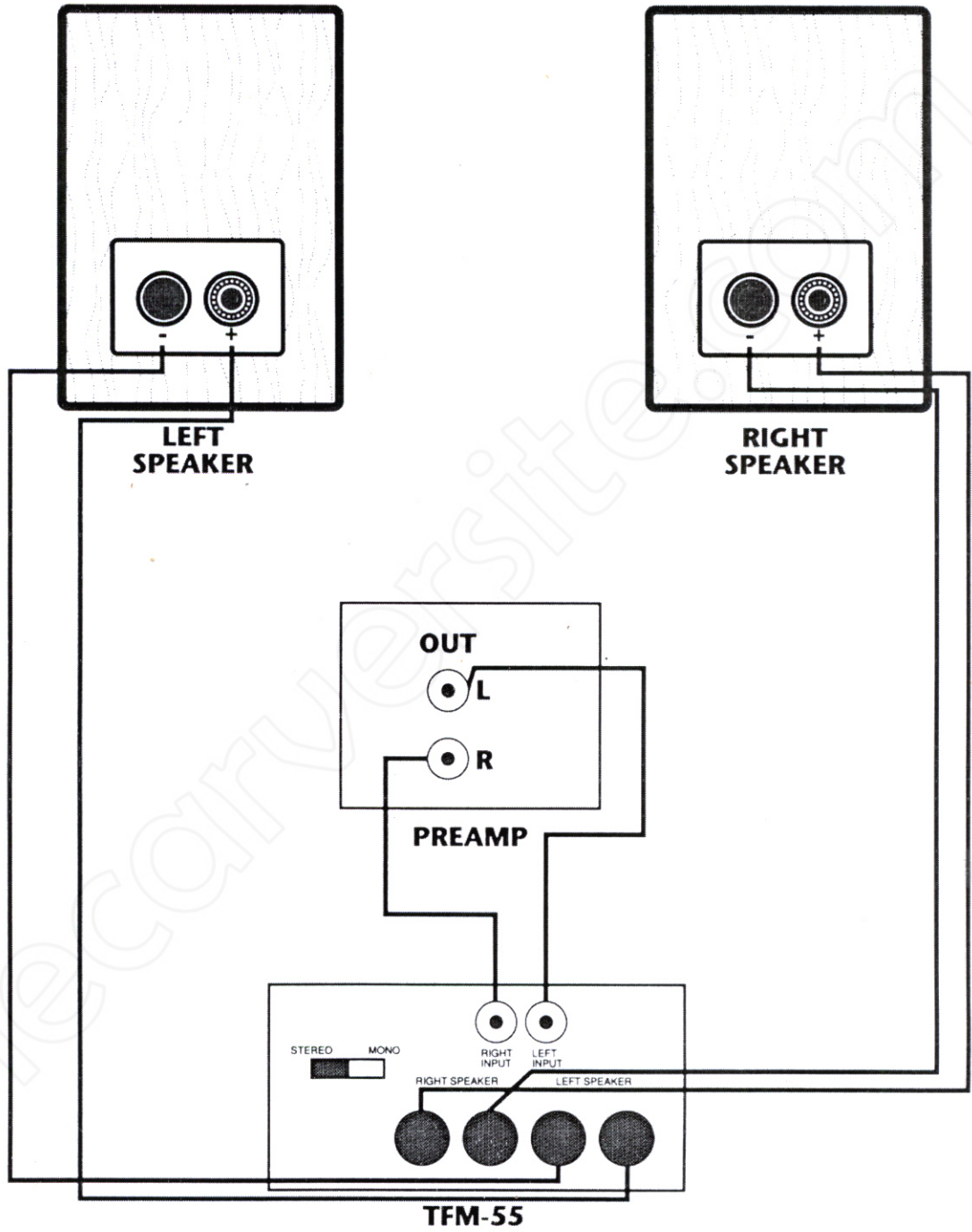

Installation Notes: Standard 2-channel installation. TFM-55 is set for stereo mode.

Suggested Hook-Up #2
Two TFM-55 Amplifiers Operating in Mono Mode

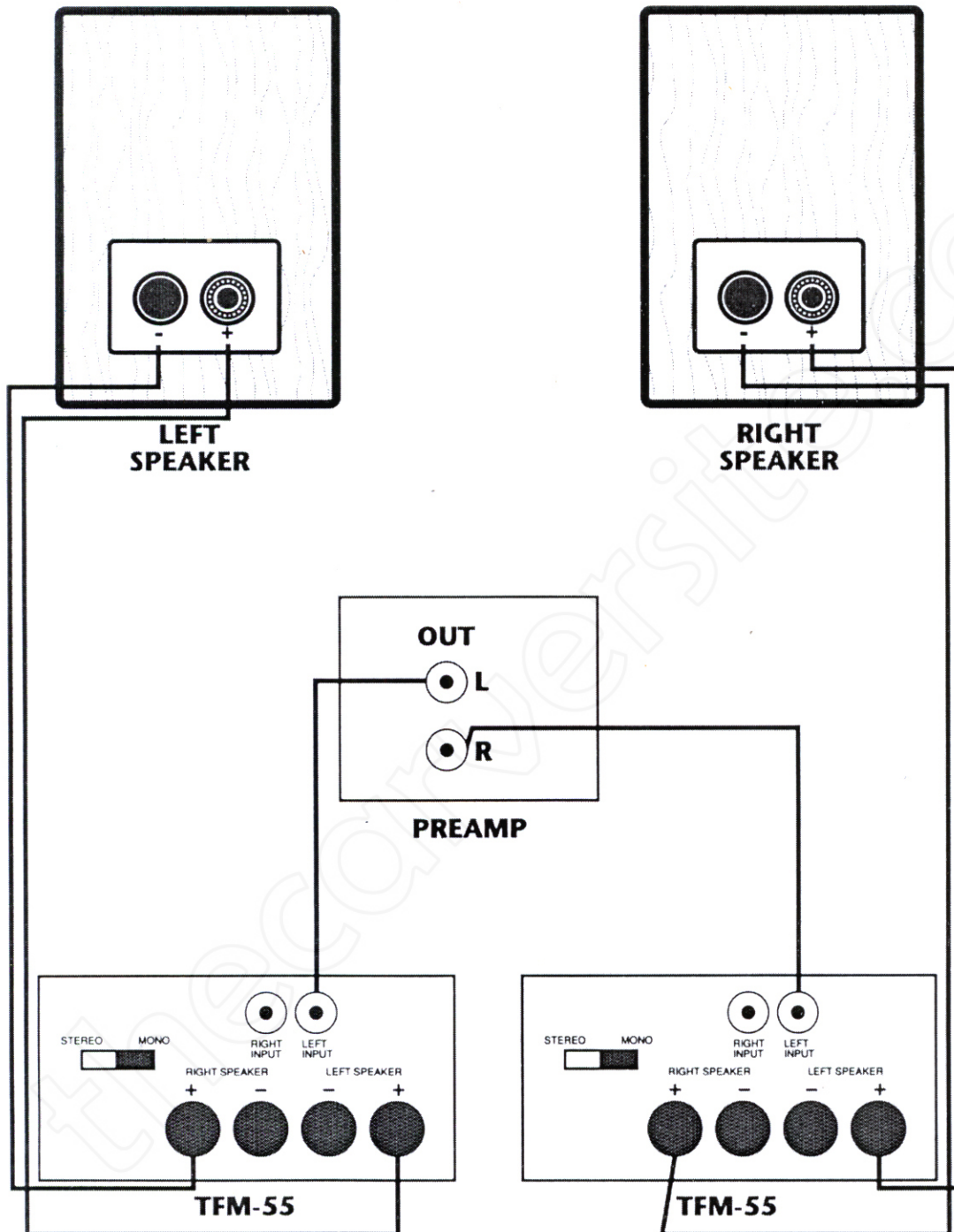

Installation Notes: Two TFM-55 amplifiers set for mono mode. Connect the Red LEFT SPEAKER Binding Post to the positive (+) speaker connection. Connect the Red RIGHT SPEAKER Binding Post to the negative (-) speaker connection. Stereo/Mono switch set to MONO.

Operation

Front panel

- 1. POWER SWITCH.** The TFM-55's POWER switch is located on the upper left-hand corner of the front panel.

When the TFM-55 is first turned on, the inputs will be muted for about four seconds to allow the amplifier to stabilize. This delay circuit helps prevent speaker-damaging thumps when powering up. We suggest you turn on the amplifier **AFTER** your have turned on your signal source (CD player, tuner, etc.). Also make sure that a loud signal source is not playing when the amplifier is turned on.

For convenience, the TFM-55 may also be connected directly to the convenience outlet of your preamplifier (if it's rated at least 1500W). If it's hooked up to a

SWITCHED OUTLET, the POWER switch on the TFM-55 may be left in the ON, position. The unit will turn ON when your preamplifier is powered up.

- 2. POWER METERS.** The TFM-55 features ballistically-weighted analog power meters that are calibrated in decibels. The main dB scale has a top value of +3dB, with 0dB equal to a continuous power (into 8 ohms) of 380 watts per channel.

The meter ballistics include a fixed amount of overshoot that's standard for this type of metering. So, on much musical material, the meter will often move past the 0dB level and on to +3dB. Because different musical material reacts differently with the ballistics of the meter, the best way to tell whether the amplifier is overloading is simply to listen. If the sound becomes distorted on musical peaks at the same time the meter is "pegging," you have probably exhausted

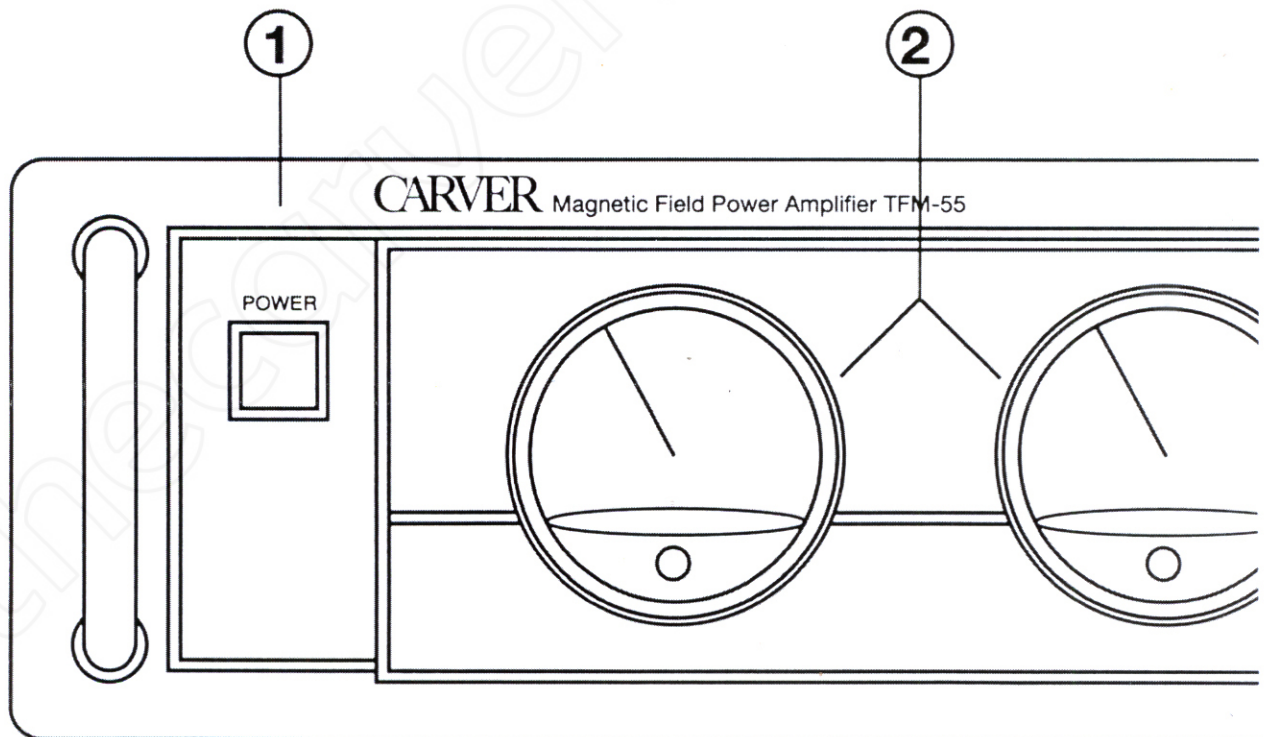

the TFM-55's power reserves. If this occurs, you should reduce the volume level to prevent the TFM-55's overload protection circuitry from being activated.

3. **RANGE SWITCH.** When pushed in, analog meter sensitivity will be increased ten-fold. (0db=37.5 watts). If you are running the TFM-55 at louder volume levels, do not activate this switch.
4. **METER DIMMER.** This button will adjust the brightness of the meters to improve viewing, depending on the lighting level in your listening room.
5. **INPUT LEVEL.** Use to fine-tune the TFM-55 to your preamplifier. Normally, the level controls are set at the maximum position (fully clockwise). These controls are concentric (one within the other); the outer control controls the left channel, the inner control controls the right channel.

Using The TFM-55.

1. Turn the TFM-55's INPUT LEVEL controls all the way down.
2. Make sure the volume control on the preamplifier is turned all the way **DOWN**.
3. Turn on your preamplifier and sound source (such as a CD player) and then turn on the TFM-55.
4. Carefully turn the **INPUT LEVEL** controls on the TFM-55 to its maximum position (fully clockwise). Listen for hum or noise. If you hear any hum and noise, consult the "Troubleshooting Guide" on page 14 of this manual.
5. Press PLAY on the sound source.
6. S-l-o-w-l-y turn up the preamplifier volume control to your "normal" listening level. If the volume increases quickly and you can't rotate the volume knob very far

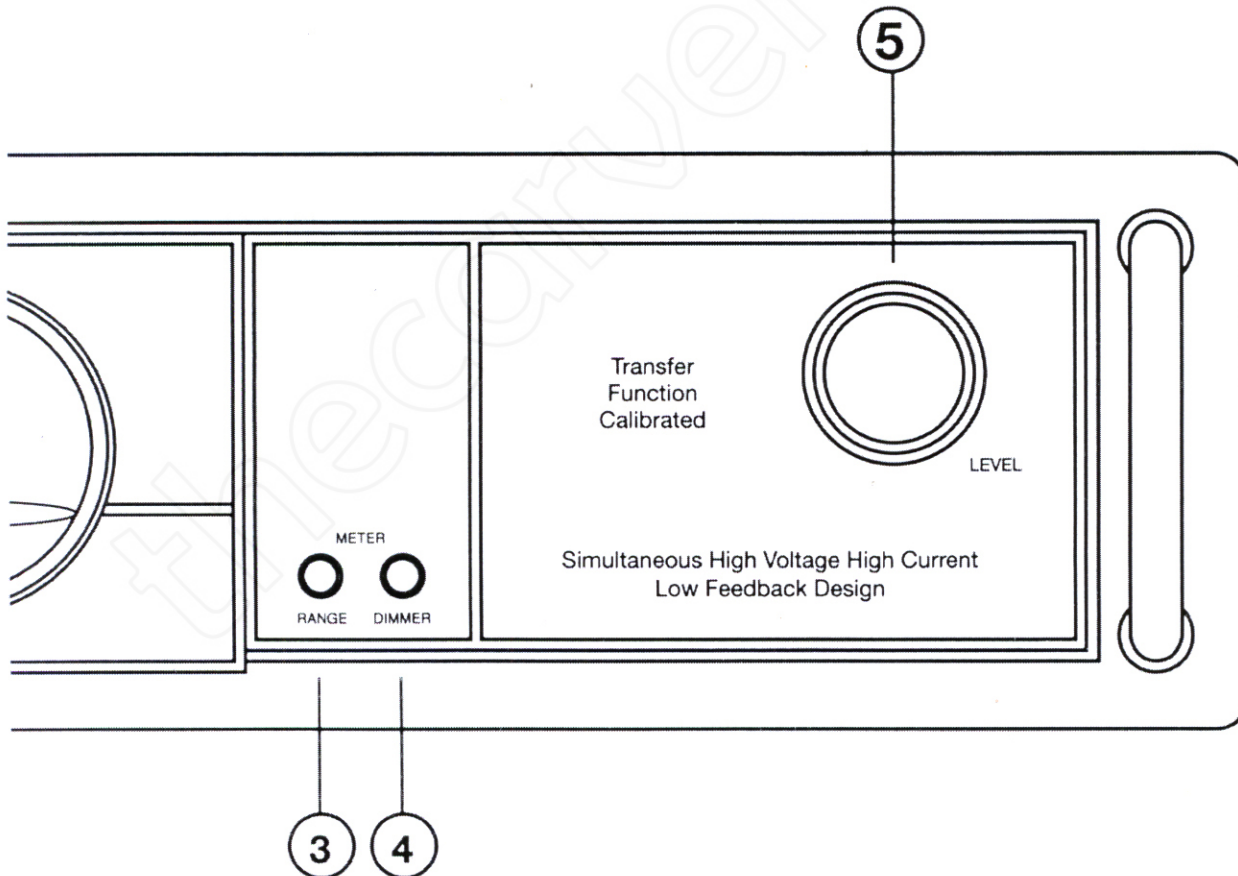

before the sound level gets deafening, turn the TFM-55's input level controls down about halfway and try again! You will want to choose a level that will give adequate adjustment range on the preamp's volume control.

Troubleshooting Guide

Before returning your TFM-55 to the dealer or Service Center for repair, review this section. In a vast majority of situations, the problem can be traced to one of the following:

1. Controls or connections are incorrect.
2. TFM-55 internal protection circuits activated.
3. TFM-55 protection fuse blown.

Nothing lights up on the TFM-55 when the POWER switch is turned on.

1. Line cord is disconnected.
2. Poor fit between plug and wall receptacle. Try removing and reinserting the plug.
3. Power is off at the wall receptacle. You can test the wall receptacle by plugging in a lamp or a tester.
4. If the TFM-55 is plugged into a preamplifier's switched receptacle, check to see if the preamplifier is turned on.
5. Power amplifier fuse is blown.

Warning: NEVER replace or check a fuse while the unit is plugged into an AC outlet. The TFM-55 must be turned OFF and unplugged for fuse replacement. Use a fuse of exactly the same rating as the one installed in the unit. If in doubt, contact your dealer.

Amplifier runs at first, then no sound.

1. Heatsink thermal switch senses high temperature. Improve top cover ventilation. Make sure that the ventilation holes are not blocked.

2. Fuse is blown.

Warning: NEVER replace or check a fuse while the unit is plugged into an AC outlet. The TFM-55 must be turned OFF and unplugged for fuse replacement. Use a fuse of exactly the same rating as the one installed in the unit. If in doubt, contact your dealer.

Sound cuts off when VOLUME control is turned up.

1. Check speaker wires for a short (bare wire from one connector touching another).
2. Check speakers for damage that may have caused an internal short.
3. Make sure that the TFM-55 is not driving an excessively low impedance speaker.

No sound at all.

First turn off your stereo system. Check preamplifier-to-power amplifier cable connections.

1. Check the input source to make sure it is working correctly. If the source unit has a headphone jack, you might use a set of headphones to check the operation of the source component.
2. Make sure that all preamplifier controls, especially the TAPE MONITOR button, are correctly set. (A TAPE MONITOR button accidentally pushed in is a frequent cause of total silence.)
3. Make sure that the TFM-55's INPUT LEVEL controls are turned up.
4. Turn the TFM-55 off. Check both speaker wire connections to make sure all connections are secure at the amplifier and the loudspeakers.
5. If speaker fuses are installed in the loudspeakers or the speaker cable, verify that they are not blown.

No sound in ONE channel or ONE channel has distorted sound.

1. Check preamplifier's BALANCE control and make sure that it is in the center position.

2. Turn the TFM-55 off. Then check speaker wire connections by momentarily switching LEFT and RIGHT speaker cables at the amplifier's speaker output terminals. After turning the unit back on, see if the same loudspeaker is dead or distorted. If it is, the fault lies with the speaker cable or the loudspeaker. If speaker fuses are installed in the loudspeakers or the speaker cable, verify that they are not blown.
3. If, after following step 2, the dead channel DOES switch sides, the problem may be in the TFM-55, the preamplifier, signal source, or connecting cables. You can check for a possible cable problem by substituting a good set of cables.

Room lights dim slightly during loud musical passages.

Because of the high current requirements of an audio amplifier at the loudest volume levels, this effect is not unusual and should not cause any harm. If you wish to reduce this dimming effect, try plugging the amplifier into an outlet operating from a different circuit breaker than the one operating the lights.

Care of Your TFM-55 Amplifier

Make every effort to keep your amplifier away from high external temperatures, moisture and airborne substances that can leave greasy deposits and dust. When panels and covers become dirty, they can be cleaned with a soft cloth slightly moistened with a mild detergent solution. Never use ammonia, abrasive cleansers or strong solvents.

Never short circuit the output terminals of the amplifier. When connecting the loudspeakers, avoid speaker wires touching at the terminals. Do not drop the amplifier. Never replace the fuse with one other than the specified rating. If you suspect a problem, try system troubleshooting first. Frequently, a problem lies elsewhere in the system or even in the connection cables.

Service Assistance

We suggest that you read the LIMITED WARRANTY completely to fully understand what your warranty/service coverage constitutes, and its duration.

If your TFM-55 should require service, we suggest you first contact the dealer from whom you purchased it. Should the dealer be unable to take care of your needs, you may contact the Carver Service Department by writing Carver Corporation, Customer Service Department, P.O. Box 1237, Lynnwood, WA 98046. Be sure to include a daytime phone number so we may call you with directions to the nearest in our national network of Authorized Warranty Service Centers, or give you detailed instructions on how to return the product to us for prompt action.

We wish you many hours of musical enjoyment. If you should have questions or comments, please write to us at the above address.

© 1992 All Rights Reserved,
Carver Corporation.
Publication No. 920314-A.
Part No. 990-20154-00.
Made in the U.S.A.

CARVER

thecarversite.com