

Nikon

DIGITAL CAMERA

COOLPIX S4100

User's Manual



En

Trademark Information

- Microsoft, Windows and Windows Vista are either registered trademarks or trademarks of Microsoft Corporation in the United States and/or other countries.
- Macintosh, Mac OS, and QuickTime are trademarks of Apple Inc., registered in the U.S. and other countries.
- Adobe and Acrobat are registered trademarks of Adobe Systems Inc.
- SDXC, SDHC, and SD Logos are trademarks of SD-3C, LLC.
- PictBridge is a trademark.
- All other trade names mentioned in this manual or the other documentation provided with your Nikon product are trademarks or registered trademarks of their respective holders.

Introduction

First Steps

Basic Photography and Playback: 📷 (Auto) Mode

More on Shooting

More on Playback

Editing Pictures

Movie Recording and Playback

Connecting to Televisions, Computers and Printers

Basic Camera Setup

Caring for the Camera

Technical Notes and Index

For Your Safety

To prevent damage to your Nikon product or injury to yourself or to others, read the following safety precautions in their entirety before using this equipment. Keep these safety instructions where all those who use the product will read them. The consequences that could result from failure to observe the precautions listed in this section are indicated by the following symbol:



This icon marks warnings, information that should be read before using this Nikon product, to prevent possible injury.

WARNINGS

Turn off in the event of malfunction

Should you notice smoke or an unusual smell coming from the camera or Charging AC adapter, unplug the Charging AC adapter and remove the battery immediately, taking care to avoid burns. Continued operation could result in injury. After removing or disconnecting the power source, take the equipment to a Nikon-authorized service representative for inspection.

Do not disassemble

Touching the internal parts of the camera or Charging AC adapter could result in injury. Repairs should be performed only by qualified technicians. Should the camera or Charging AC adapter break open as the result of a fall or other accident, take the product to a Nikon-authorized service representative for inspection, after unplugging the product and/or removing the battery.

Do not use the camera or Charging AC adapter in the presence of flammable gas

Do not use electronic equipment in the presence of flammable gas, as this could result in explosion or fire.

Handle the camera strap with care

Never place the strap around the neck of an infant or child.

Keep out of reach of children

Particular care should be taken to prevent infants from putting the battery or other small parts into their mouths.

Observe caution when handling the battery

The battery may leak or explode if improperly handled. Observe the following precautions when handling the battery for use in this product:

- Before replacing the battery, turn the product off. If you are using the Charging AC Adapter/AC adapter, be sure it is unplugged.
- Use only a Rechargeable Li-ion Battery EN-EL19 (supplied). Charge the battery inserted into the camera by connecting the Charging AC Adapter EH-69P (supplied).
- When inserting the battery, do not attempt to insert it upside down or backwards.
- Do not short or disassemble the battery or attempt to remove or break the battery insulation or casing.
- Do not expose the battery to flame or to excessive heat.
- Do not immerse in or expose to water.
- Return the battery to the battery case for transportation. Do not transport or store with metal objects such as necklaces or hairpins.
- The battery is prone to leakage when fully discharged. To avoid damage to the product, be sure to remove the battery when no charge remains.
- Discontinue use immediately should you notice any change in the battery, such as discoloration or deformation.

Observe the following precautions when handling the Charging AC Adapter

- If liquid from the damaged battery comes in contact with clothing or skin, rinse immediately with plenty of water.
- Keep dry. Failure to observe this precaution could result in fire or electric shock.
- Dust on or near the metal parts of the plug should be removed with a dry cloth. Continued use could result in fire.
- Do not handle the plug or go near the Charging AC Adapter during lightning storms. Failure to observe this precaution could result in electric shock.
- Do not damage, modify, forcibly tug or bend the USB cable, place it under heavy objects, or expose it to heat or flames. Should the insulation be damaged and the wires become exposed, take it to a Nikon-authorized service representative for inspection. Failure to observe these precautions could result in fire or electric shock.
- Do not handle the plug or Charging AC Adapter with wet hands. Failure to observe this precaution could result in electric shock.
- Do not use with travel converters or adapters designed to convert from one voltage to another or with DC-to-AC inverters. Failure to observe this precaution could damage the product or cause overheating or fire.

 **Use appropriate cables**

When connecting cables to the input and output jacks, use only the cables provided or sold by Nikon for the purpose, to maintain compliance with product regulations.

 **Handle moving parts with care**

Be careful that your fingers or other objects are not pinched by the lens cover or other moving parts.

 **CD-ROMs**

The CD-ROMs supplied with this device should not be played back on audio CD equipment. Playing CD-ROMs on an audio CD player could cause hearing loss or damage the equipment.

 **Observe caution when using the flash**

Using the flash close to your subject's eyes could cause temporary visual impairment. Particular care should be observed if photographing infants, when the flash should be no less than one meter (3 ft. 4 in.) from the subject.

 **Do not operate the flash with the flash window touching a person or object**

Failure to observe this precaution could result in burns or fire.

 **Avoid contact with liquid crystal**

Should the monitor break, care should be taken to avoid injury caused by broken glass and to prevent liquid crystal from the monitor touching the skin or entering the eyes or mouth.

 **Turn the power off when using inside an airplane or the hospital**

Turn the power off while inside the airplane during take off or landing. Follow the instructions of the hospital when using while in a hospital. The electromagnetic waves given out by this camera may disrupt the electronic systems of the airplane or the instruments of the hospital.

Notices

Notices for Customers in the U.S.A.

IMPORTANT SAFETY INSTRUCTIONS— SAVE THESE INSTRUCTIONS.

DANGER - TO REDUCE THE RISK OF FIRE OR ELECTRIC SHOCK, CAREFULLY FOLLOW THESE INSTRUCTIONS

For connection to a supply not in the U.S.A., use an attachment plug adapter of the proper configuration for the power outlet if needed.

The power supply unit is intended to be correctly orientated in a vertical or floor mount position.

Federal Communications Commission (FCC) Radio Frequency Interference Statement

This equipment has been tested and found to comply with the limits for a Class B digital device, pursuant to Part 15 of the FCC rules. These limits are designed to provide reasonable protection against harmful interference in a residential installation. This equipment generates, uses, and can radiate radio frequency energy and, if not installed and used in accordance with the instructions, may cause harmful interference to radio communications. However, there is no guarantee that interference will not occur in a particular installation. If this equipment does cause harmful interference to radio or television reception, which can be determined by turning the equipment off and on, the user is encouraged to try to correct

the interference by one or more of the following measures:

- Reorient or relocate the receiving antenna.
- Increase the separation between the equipment and receiver.
- Connect the equipment into an outlet on a circuit different from that to which the receiver is connected.
- Consult the dealer or an experienced radio/television technician for help.



Nikon

COOLPIX S4100

CAUTIONS

Modifications

The FCC requires the user to be notified that any changes or modifications made to this device that are not expressly approved by Nikon Corporation may void the user's authority to operate the equipment.

Interface Cables

Use the interface cables sold or provided by Nikon for your equipment. Using other interface cables may exceed the limits of Class B Part 15 of the FCC rules.

Notice for customers in the State of California

WARNING

Handling the cord on this product will expose you to lead, a chemical known to the State of California to cause birth defects or other reproductive harm.

Wash hands after handling.

Nikon Inc.,
1300 Walt Whitman Road
Melville, New York 11747-3064
USA
Tel: 631-547-4200

Notice for customers in Canada

CAUTION

This Class B digital apparatus complies with Canadian ICES-003.

ATTENTION

Cet appareil numérique de la classe B est conforme à la norme NMB-003 du Canada.

Notices for customers in Europe

CAUTION

RISK OF EXPLOSION IF BATTERY IS REPLACED BY AN INCORRECT TYPE.

DISPOSE OF USED BATTERIES ACCORDING TO THE INSTRUCTIONS.

This symbol indicates that this product is to be collected separately.

The following apply only to users in European countries:

- This product is designated for separate collection at an appropriate collection point. Do not dispose of as household waste.
- For more information, contact the retailer or the local authorities in charge of waste management.

This symbol on the battery indicates that the battery is to be collected separately.



The following apply only to users in European countries:

- All batteries, whether marked with this symbol or not, are designated for separate collection at an appropriate collection point. Do not dispose of as household waste.
- For more information, contact the retailer or the local authorities in charge of waste management.



Table of Contents



















For Your Safety	ii
WARNINGS	ii
Notices	v
Introduction	1
About This Manual	1
Information and Precautions	2
Parts of the Camera	4
The Camera Body	4
Basic Operations	6
The  (Shooting Mode) Button	6
The  (Playback) Button	6
The  (Movie-record) Button	6
Shutter-release Button	7
Attaching the Camera Strap	7
Operating the Touch Panel	8
Tapping	8
Dragging	8
Dragging and Dropping	8
Using the Stylus	9
Main Display of the Monitor/Touch Panel and Basic Operations	10
Shooting (Information Display)	10
Shooting (Operation Controls)	11
Playback (Information Display)	12
Playback (Operation Controls)	13
Operating the Tabs	14
First Steps	16
Inserting the Battery	16
Removing the Battery	17
Charging the Battery	18
Turning On and Off the Camera	21
Setting Display Language, Date and Time	22
Inserting Memory Cards	24
Removing Memory Cards	24
Basic Photography and Playback:  (Auto) Mode	26
Step 1 Turn the Camera On and Select  (Auto) Mode	26
Indicators Displayed in  (Auto) Mode	27
Step 2 Frame a Picture	28
Using the Zoom	29
Step 3 Focus and Shoot	30
Step 4 Playing Back and Deleting Pictures	32
Playing Back Pictures (Playback Mode)	32

Table of Contents

Deleting Unwanted Pictures	33
Using the Basic Shooting Functions	34
 Flash Mode	34
 Taking Pictures with the Self-timer	36
 Macro Mode	38
 Changing the Brightness Using Exposure Compensation.....	39
<hr/>	
More on Shooting	40
Selecting a Shooting Mode	40
Adjusting the  (Auto) Mode setting.....	42
 Image Mode (Changing Image Quality/Image Size).....	43
 Touch Shutter (Tapping the Monitor to Release the Shutter).....	45
 Subject Tracking (Focusing on a Moving Subject).....	48
 Touch AF/AE (Tapping the Monitor to Focus).....	50
 ISO Sensitivity.....	53
 Continuous.....	54
 White Balance (Adjusting Hue).....	55
Shooting Suited to Scenes (Scene Mode)	58
Selecting a Scene Mode.....	58
Shooting in the Scene Mode Selected by the Camera (Scene Auto Selector).....	61
Selecting a Scene Mode to Take Pictures (Features).....	63
Using the Draw Option.....	71
Shooting for a Panorama.....	72
Shooting Smiling Faces (Smart Portrait Mode)	74
Changing the Smart Portrait Mode Settings.....	76
Camera Settings that Cannot Be Applied Simultaneously	78
<hr/>	
More on Playback.....	80
Operations in Full-frame Playback Mode.....	80
Viewing Multiple Pictures: Thumbnail Playback	81
Taking a Closer Look: Playback Zoom	83
Selecting Playback Mode	85
Sorting Favorite Pictures (Favorite Pictures Mode)	86
Adding Pictures to Albums	86
Viewing Pictures in an Album.....	88
Removing Pictures from Albums.....	89
Operations in Favorite Pictures Mode	90
Changing Icons Assigned to Albums.....	91
Image Searching in Auto Sort Mode.....	93
Viewing Pictures in Auto Sort Mode	93
Operations in Auto Sort Mode	95
Selecting Pictures Taken on a Specific Day (List by Date Mode)	96
Selecting a Date in List by Date Mode	96
Operations in List by Date Mode	97



































Playback Options	98
Setting the Picture Rating.....	99
Playing Back Pictures by Rating.....	99
 Enjoying Slide Show	100
 Protecting Important Pictures (Protect).....	101
Protecting One Picture.....	101
Protecting Multiple Pictures	102
Removing Protection from Pictures.....	102
 Creating a DPOF Print Order.....	103
Creating a Print Order for One Picture	103
Creating a Print Order for Multiple Pictures	105
Canceling Print Order.....	106
 Rotate Image	107
 Voice Memo: Recording and Playback	108
Recording Voice Memos.....	108
Playing Voice Memos.....	109
Deleting Voice Memos.....	109
<hr/>	
Editing Pictures	110
Editing Functions.....	110
Picture Editing.....	112
 Paint.....	112
 Quick Retouch: Enhancing Contrast and Saturation.....	115
 D-Lighting: Enhancing Brightness and Contrast	116
 Stretch: Stretching Pictures.....	117
 Perspective Control: Adjusting a Sense of Perspective	118
 Filter Effects (Digital Filter)	119
 Glamour Retouch.....	121
 Small Picture: Making Smaller Pictures.....	123
 Crop: Creating a Cropped Copy	124
<hr/>	
Movie Recording and Playback.....	126
Recording Movies	126
Changing the Movie Recording Settings	128
 Movie Options.....	128
 Movie AF Mode	129
 Wind Noise Reduction	130
Movie Playback.....	131
<hr/>	
Connecting to Televisions, Computers and Printers	132
Connecting to a TV.....	132
Connecting to a Computer.....	134
Before Connecting the Camera.....	134
Transferring Images from a Camera to a Computer	135
Charging While Connecting to a Computer	139

Table of Contents

Connecting to a Printer.....	140
Connecting the Camera to a Printer.....	141
Printing Pictures One at a Time.....	142
Printing Multiple Pictures.....	143
<hr/>	
Basic Camera Setup.....	146
Setup Menu.....	146
Operating the Setup Menu.....	147
 Welcome Screen.....	148
 Time Zone and Date.....	149
 Monitor Settings.....	152
 Print Date (Imprinting Date and Time).....	153
 Electronic VR.....	154
 Motion Detection.....	155
 AF Assist.....	156
 Digital Zoom.....	156
 Sound Settings.....	157
 Auto Off.....	158
 Format Memory/Format Card.....	159
 Language.....	160
 Video Mode.....	160
 Charge by Computer.....	161
 Blink Warning.....	162
 Reset All.....	164
 Copy (Copy Between Internal Memory and Memory Card).....	167
 Firmware Version.....	168
<hr/>	
Caring for the Camera.....	169
Maximizing Camera Life and Performance.....	169
Cleaning.....	171
Storage.....	171
<hr/>	
Technical Notes and Index.....	172
Optional Accessories.....	172
Approved Memory Cards.....	173
Image/Sound File and Folder Names.....	174
Error Messages.....	175
Troubleshooting.....	180
Specifications.....	187
Supported Standards.....	190
Index.....	191

About This Manual

Thank you for your purchase of a Nikon COOLPIX S4100 digital camera. This manual was written to help you enjoy taking pictures with your Nikon digital camera. Read this manual thoroughly before use, and keep it where all those who use the product will read it.

Symbols and Conventions

To make it easier to find the information you need, the following symbols and conventions are used:



This icon marks cautions, information that should be read before use, to prevent damage to the camera.



This icon marks tips, additional information that may be helpful when using the camera.



This icon marks notes, information that should be read before using the camera.



This icon indicates that more information is available elsewhere in this manual.

Notations

- Secure Digital (SD) memory card, SDHC memory card, and SDXC memory card are referred to as “memory card.”
- The setting at the time of purchase is referred to as the “default setting.”
- The names of menu items displayed in the camera monitor, and the names of buttons or messages displayed on a computer monitor appear in bold.

Screen Samples

In this manual, images are sometimes omitted from monitor display samples so that monitor indicators can be more clearly shown.

Illustrations and Screen Display

Illustrations and text displays shown in this manual may differ from actual display.

Internal Memory and Memory Cards

Pictures taken with this camera can be stored in the camera's internal memory or on removable memory cards. If a memory card is inserted, all new pictures will be stored on the memory card and delete, playback and format operations will apply only to the pictures on the memory card. The memory card must be removed before the internal memory can be formatted or accessed for picture storage, deletion, or viewing.

Information and Precautions

Life-Long Learning

As part of Nikon's "Life-Long Learning" commitment to ongoing product support and education, continually updated information is available online at the following sites:

- For users in the U.S.A.: <http://www.nikonusa.com/>
- For users in Europe and Africa: <http://www.europe-nikon.com/support/>
- For users in Asia, Oceania, and the Middle East: <http://www.nikon-asia.com/>

Visit these sites to keep up-to-date with the latest product information, tips, answers to frequently asked questions (FAQs), and general advice on digital imaging and photography. Additional information may be available from the Nikon representative in your area. Visit the site below for contact information:

<http://imaging.nikon.com/>

Use Only Nikon Brand Electronic Accessories

Nikon COOLPIX cameras are designed to the highest standards and include complex electronic circuitry. Only Nikon brand electronic accessories (including battery chargers, batteries, Charging AC Adapter, and AC adapters) certified by Nikon specifically for use with this Nikon digital camera are engineered and proven to operate within the operational and safety requirements of this electronic circuitry.

THE USE OF NON-NIKON ELECTRONIC ACCESSORIES COULD DAMAGE THE CAMERA AND MAY VOID YOUR NIKON WARRANTY.

The use of third-party rechargeable Li-ion batteries not bearing the Nikon holographic seal could interfere with normal operation of the camera or result in the batteries overheating, igniting, rupturing, or leaking.

For more information about Nikon brand accessories, contact a local authorized Nikon dealer.



Holographic seal:

Identifies this device as an authentic Nikon product.

Before Taking Important Pictures

Before taking pictures on important occasions (such as at weddings or before taking the camera on a trip), take a test shot to ensure that the camera is functioning normally. Nikon will not be held liable for damages or lost profits that may result from product malfunction.

About the Manuals

- No part of the manuals included with this product may be reproduced, transmitted, transcribed, stored in a retrieval system, or translated into any language in any form, by any means, without Nikon's prior written permission.
- Nikon reserves the right to change the specifications of the hardware and software described in these manuals at any time and without prior notice.
- Nikon will not be held liable for any damages resulting from the use of this product.
- While every effort was made to ensure that the information in these manuals is accurate and complete, we would appreciate it were you to bring any errors or omissions to the attention of the Nikon representative in your area (address provided separately).

Notice Concerning Prohibition of Copying or Reproduction

Note that simply being in possession of material that was digitally copied or reproduced by means of a scanner, digital camera or other device may be punishable by law.

• **Items prohibited by law from being copied or reproduced**

Do not copy or reproduce paper money, coins, securities, government bonds or local government bonds, even if such copies or reproductions are stamped "Sample." The copying or reproduction of paper money, coins, or securities which are circulated in a foreign country is prohibited. Unless the prior permission of the government was obtained, the copying or reproduction of unused postage stamps or post cards issued by the government is prohibited. The copying or reproduction of stamps issued by the government and of certified documents stipulated by law is prohibited.

• **Cautions on certain copies and reproductions**

The government has issued cautions on copies or reproductions of securities issued by private companies (shares, bills, checks, gift certificates, etc.), commuter passes or coupon tickets, except when a minimum of necessary copies are to be provided for business use by a company. Also, do not copy or reproduce passports issued by the government, licenses issued by public agencies and private groups, ID cards and tickets, such as passes and meal coupons.

• **Comply with copyright notices**

The copying or reproduction of copyrighted creative works such as books, music, paintings, woodcut prints, maps, drawings, movies and photographs is governed by national and international copyright laws. Do not use this product for the purpose of making illegal copies or to infringe copyright laws.

Disposing of Data Storage Devices

Please note that deleting images or formatting data storage devices such as memory cards or built-in camera memory does not completely erase the original image data. Deleted files can sometimes be recovered from discarded storage devices using commercially available software, potentially resulting in the malicious use of personal image data. Ensuring the privacy of such data is the user's responsibility.

Before discarding a data storage device or transferring ownership to another person, erase all data using commercial deletion software, or format the device and then completely refill it with images containing no private information (for example, pictures of empty sky). Be sure to also replace any pictures selected for the welcome screen (📖 148). Care should be taken to avoid injury or damage to property when physically destroying data storage devices.

Parts of the Camera

The Camera Body

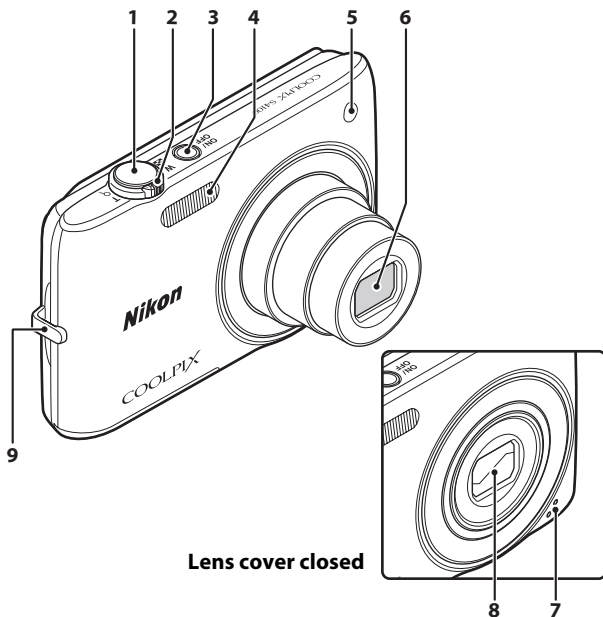

Lens cover closed

1	Shutter-release button.....	30	4	Flash.....	34
2	Zoom control.....	29	5	Self-timer lamp.....	36
	W : Wide-angle.....	29	AF : AF-assist illuminator.....	156	
	T : Telephoto.....	29	6	Lens.....	171, 187
	: Thumbnail playback.....	81	7	Built-in microphone.....	108, 126
	: Playback zoom.....	83	8	Lens cover.....	169
3	Power switch/power-on lamp		9	Eyelet for camera strap.....	7
	21, 26, 158			

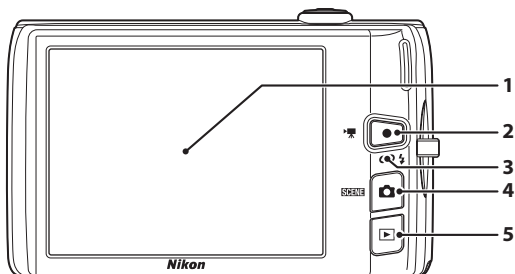

Under the connector cover

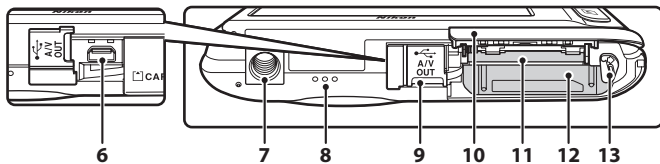





1	Monitor/touch panel.....	10, 27
2	● (▶ movie-record) button.....	6, 126
3	Charge lamp.....	19, 139
	Flash lamp.....	35
4	📷 (shooting mode) button.....	6, 40
5	▶ (playback) button.....	6, 32, 85
6	USB/audio/video output connector	132, 135, 141

7	Tripod socket	
8	Speaker.....	109, 131
9	Connector cover.....	132, 135, 141
10	Battery-chamber/ memory card slot cover.....	16, 24
11	Memory card slot.....	24
12	Battery chamber.....	16
13	Battery latch.....	16, 17

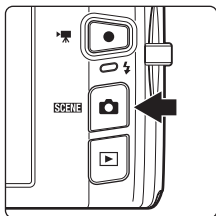
Basic Operations





The (Shooting Mode) Button

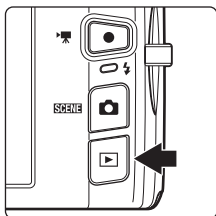

- Press the  button in playback mode to enter shooting mode.
- Press the  button in shooting mode to display the shooting-mode selection menu and switch shooting modes ( 40).





The (Playback) Button

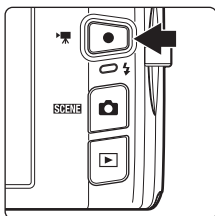

- Press the  button in shooting mode to enter playback mode.
- Press the  button in playback mode to display the playback-mode selection menu and switch playback modes ( 85).
- If the camera is turned off, hold down the  button to turn the camera on in playback mode.

The (Movie-record) Button



- Press the  (movie-record) button in shooting mode to start movie recording ( 126). Press the  (movie-record) button again to stop movie recording.
- Press the  (movie-record) button in playback mode to enter shooting mode.

Shutter-release Button

The camera features a two-stage shutter-release button. To set focus and exposure, press the shutter-release button halfway, stopping when you feel resistance. When the shutter-release button is pressed halfway, focus and exposure (shutter speed and aperture value) are set. Focus and exposure remain locked while the shutter-release button is pressed halfway.

While the shutter-release button is held in this position, release the shutter and take a picture by pressing the shutter-release button the rest of the way down. Do not use force when pressing the shutter-release button, as this may result in camera shake and blurred images.



Press the shutter-release button halfway to set focus and exposure



Press the shutter-release button the rest of the way down to take picture

Attaching the Camera Strap

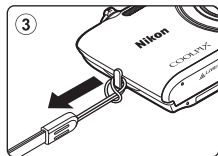
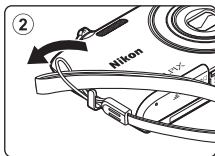

Operating the Touch Panel

The monitor on the COOLPIX S4100 is a touch panel display. Use a finger or the supplied stylus to operate the touch panel.

Tapping

Tap the touch panel.

Use this operation to:

Select icons or other controls

Select pictures in thumbnail playback mode

([81](#))

Perform touch shutter ([45](#)), touch AF/AE ([50](#)), or subject tracking ([48](#)) operations

Drag the tab to display the setting controls during shooting or playback ([14](#))

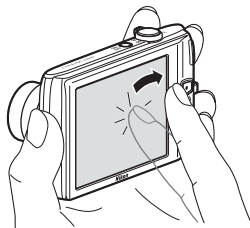

Dragging

Drag your finger across the touch panel and remove it from the touch panel.

Use this operation to:

Scroll through pictures in full-frame playback mode

([32](#))

Move the visible portion of a picture enlarged with playback zoom ([83](#))

Use sliders to adjust exposure compensation ([39](#)) or other settings

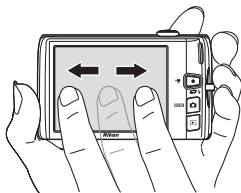

Dragging and Dropping

Place your finger on the touch panel, drag it to the desired location (①), and remove it from the touch panel (②).

Use this operation to:

Apply the rating setting ([99](#))

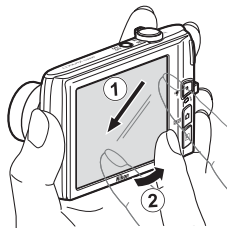

Using the Stylus

Use the stylus for operations, such as when using the draw option (📖 71) or the paint option (📖 112), that require more precision than using a finger.



Attaching the Stylus

Attach the stylus to the strap as shown.

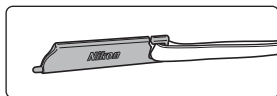

✔ Notes on the Touch Panel

- Do not press on the touch panel with pointed objects other than the supplied stylus.
- Do not apply unnecessary pressure to the touch panel.

✔ Notes on Tapping/Dragging

- The camera may not respond if your finger is left in one place too long.
- The camera may not respond if the followings are made.
 - Bounce your finger off the display
 - Drag your finger over too short a distance
 - Stroke the display too lightly
 - Move your finger too quickly
- The camera may not respond if something else is touching the touch panel when your finger touches it.

✔ Notes on the Touch Panel

- Keep the stylus out of reach of small children.
- Do not carry the camera by the stylus. The stylus may slip off the strap and the camera may fall.

Main Display of the Monitor/Touch Panel and Basic Operations

Shooting (Information Display)

Displayed information on the monitor varies depending on the camera settings or status.

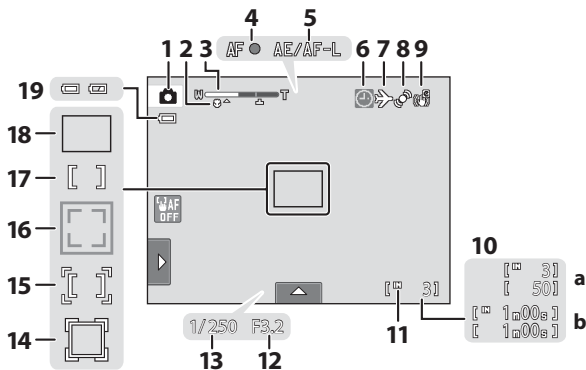

1	Shooting mode ¹	26, 58, 74
2	Macro mode	38
3	Zoom indicator	29, 38
4	Focus indicator	30
5	AE/AF-L indicator	73
6	"Date not set" indicator	175
	Print date indicator	153
7	Travel destination icon	149
8	Motion detection icon	155
9	Electronic VR icon	154

10	a Number of exposures remaining (still pictures) ²	26
	b Movie length	126
11	Internal memory indicator	27
12	Aperture	30
13	Shutter speed	30
14	Focus area (subject tracking mode)	48
15	Focus area (touch AF/AE)	50
16	Focus area (face or pet detection)	30, 70, 74
17	Focus area (center)	
18	Focus area (auto)	30
19	Battery level indicator	26

¹ Indicators displayed vary with current shooting mode.

² Indicator is displayed when there are 50 or fewer exposures remaining.

Shooting (Operation Controls)

Tap the following controls to change settings.

- Tap the tab to display the setting controls and shooting settings can be changed (📖 14).
- The controls available and indicators displayed vary with shooting mode and the current camera settings.

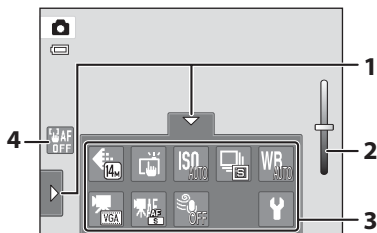

1	Tab.....	14	3	Setting controls.....	15
2	Scene effect adjustment slider.....	60	4	Touch AF/AE cancellation.....	50

Playback (Information Display)

The following monitor display shows information for the picture currently displayed and camera status.

- The displayed information vary depending on the picture played back and the current camera status.
- Indicators below are displayed when turning on the camera or operating the camera, and turn off after a few seconds elapse (📖 152).

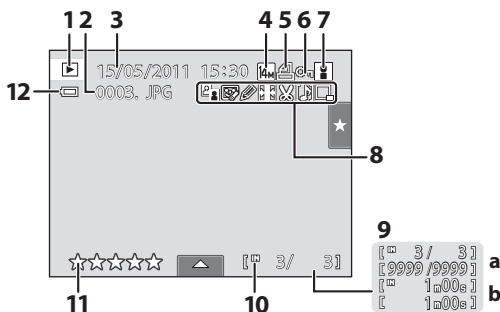

1	Playback mode ¹	32, 86, 93, 96
2	File number and type.....	174
3	Date/time of recording.....	22
4	Image mode ²	43
	Movie options ²	128
5	Print order icon.....	103
6	Protect icon.....	101
7	Album icon in favorite pictures mode ³	88
	Category icon in auto sort mode ³	93

8	Quick retouch icon.....	115
	D-Lighting icon.....	116
	Glamour retouch icon.....	121
	Filter effects icon.....	119
	Paint icon.....	112
	Stretch icon.....	117
	Perspective control icon.....	118
	Crop icon.....	124
	Voice memo icon.....	109
	Small picture icon.....	123
9	a Current frame number/ total number of frames.....	32
	b Movie length.....	131
10	Internal memory indicator.....	27
11	Rating indicator.....	99
12	Battery level indicator.....	26

¹ Indicators displayed vary with current playback mode.

² Indicators displayed vary depending on the setting for shooting.

³ The icon for the selected album or category in auto sort mode currently selected in playback mode is displayed.

Playback (Operation Controls)

Tap the following controls to change settings.



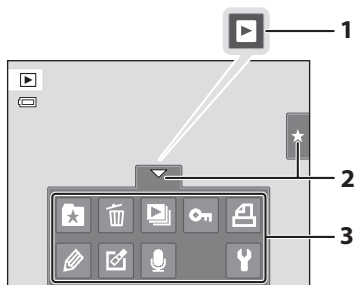

- Tap the tab to display the setting controls and deleting or editing will be available (📖 14).
- The controls available and indicators displayed vary with the picture played back and the current camera settings.



1	Movie playback.....	131	3	Setting controls.....	15
2	Tab.....	14			

Operating the Tabs

When in shooting or playback mode, use the setting controls to make shooting or playback settings. Display the controls by tapping the tab at the bottom, left and right sides of the monitor.

- Tap the icon of the desired item to display the setting screen for that item.
- Tap  (setup) in the setting controls to make the basic camera settings.
- When  or  is displayed on the setting screen, tap  to exit the setting screen. Tap  to return to the previous screen.
- Tap the tab again to hide the setting controls.

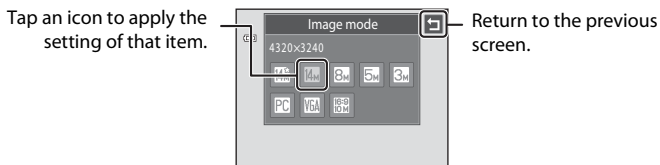
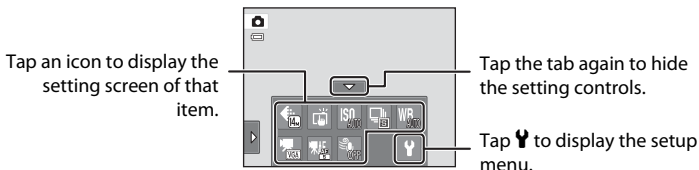
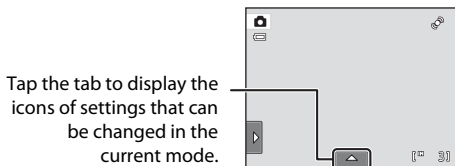

Shooting

Shooting settings can be made.

- The available setting items vary depending on the shooting mode (40).
- Each icon also indicates the current setting.

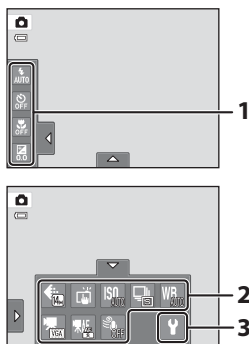

1	Flash mode	34
	Self-timer	36
	Macro mode	38
	Exposure compensation	39
	Image mode	43
	Touch shooting	
	Touch shutter	45
	Subject tracking	48
	Touch AF/AE	50
2	ISO sensitivity	53
	Continuous	54
	White balance	55
	Movie options	128
	Movie AF mode	129
	Wind noise reduction	130
3	Setup	146

Playback

Pictures can be edited and deleted, and playback settings can be made.

- The available setting items vary depending on the type of picture or playback mode.

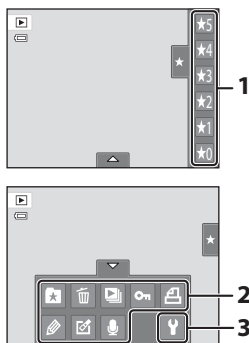

1	Rating	99
	Add pictures to albums (except in favorite pictures mode)	86
	Remove pictures from albums (in favorite pictures mode)	89
	Delete	33
2	Slide show	100
	Protect	101
	DPOF print order	103
	Paint	112
	Retouch	110
	Voice memo	108
3	Setup	146

Inserting the Battery

Insert a Rechargeable Li-ion Battery EN-EL19 (supplied) into the camera.

- Charge the battery before the first use or when the battery is running low (📖 18).

- 1 Open the battery-chamber/memory card slot cover.

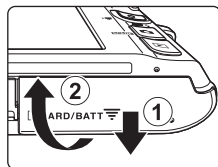

- 2 Insert the battery.

Use the edge of the battery to push the orange battery latch in the direction indicated by the arrow (1) and fully insert the battery (2).

When the battery is fully inserted, the battery latch will lock it in place.

Battery chamber

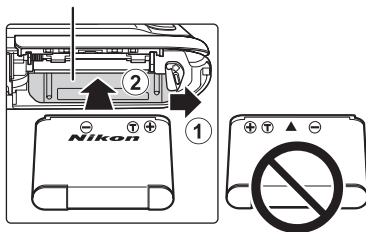

✔ Inserting the Battery

Inserting the battery upside down or backwards could damage the camera. Be sure to check that the battery is in the correct orientation.

- 3 Close the battery-chamber/memory card slot cover.

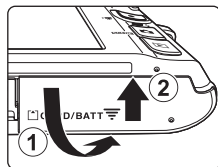

Removing the Battery

Turn the camera off (📖 21) and be sure that the power-on lamp and the monitor have turned off before opening the battery-chamber/memory card slot cover.

To eject the battery, open the battery-chamber/memory card slot cover and slide the orange battery latch in the direction indicated by the arrow (①). The battery can then be removed by hand (②).

- Note that the camera, battery, and memory card may become hot during use; observe caution when removing the battery or memory card.

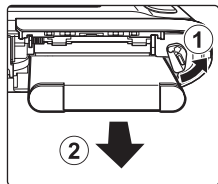

✓ Notes on the Battery

- Be sure to read and follow the warnings for the battery on page iii and the section, "The Battery" (📖 170), before use.
- If the battery will not be used for an extended period, recharge it at least once every six months and run it flat before returning it to storage.

Charging the Battery

Charge the supplied Rechargeable Li-ion Battery EN-EL19 inserted into the camera, by connecting the supplied Charging AC Adapter EH-69P to the camera via the supplied USB Cable UC-E6, and then plugging the Charging AC Adapter into an electrical outlet.

1 Prepare the Charging AC Adapter EH-69P.

If a plug adapter* is included, attach the plug adapter to the plug on the Charging AC Adapter. Push the plug adapter firmly until it is securely held in place. Once the two are connected, attempting to forcibly remove the plug adapter could damage the product.

* The shape of the plug adapter varies according to the country or region in which the camera was purchased. The Charging AC Adapter comes with the plug adapter attached in Argentina and Korea.

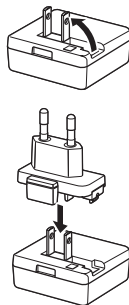

2 Insert the battery (📖 16).

Do not turn the camera on.

3 Use the supplied USB cable to connect the Charging AC Adapter to the camera.

Be sure that connectors are properly oriented. Do not attempt to insert connectors at an angle, and do not use force when connecting or disconnecting the USB cable.

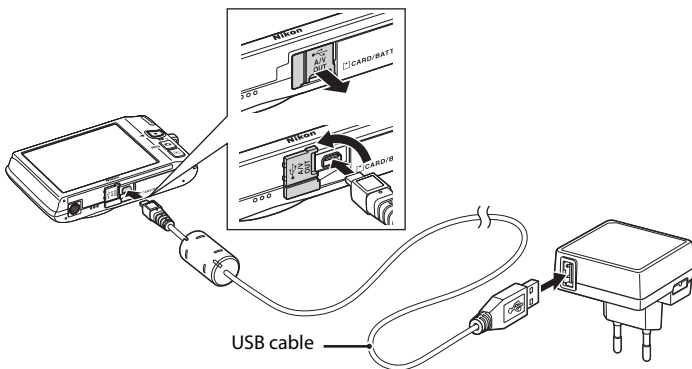

4 Plug the Charging AC Adapter into an electrical outlet.

The charge lamp slowly blinks green to indicate that the battery is charging.

About two hours and ten minutes are required to charge a fully exhausted battery.

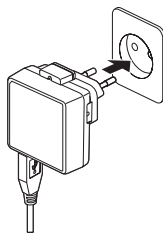

The following chart explains charge lamp status when the camera is plugged into the electrical outlet.

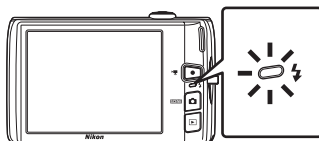

Charge lamp	Description
Blinks slowly (green)	Battery charging.
Off	Battery not charging. When charging is complete, the charge lamp stops blinking green and turns off.
Flickers (green)	<ul style="list-style-type: none"> The ambient temperature is not suited to charging. Charge the battery indoors with an ambient temperature of 5°C to 35°C (41°F to 95°F). The USB cable or Charging AC Adapter is not properly connected, or there is a problem with the battery. Disconnect the USB cable or unplug the Charging AC Adapter and correctly connect it again, or change the battery.

5 Disconnect the Charging AC Adapter from the electrical outlet and then disconnect the USB cable.

Charging the Battery

Notes on Charging AC Adapter

- The Charging AC Adapter EH-69P is for use only with compatible devices. Do not use with another make or model of device.
- Be sure to read and follow the warnings for the Charging AC Adapter on page iii and the section, “The Battery” (📖 170), before use.
- The EH-69P is compatible with AC 100-240 V, 50/60 Hz electrical outlets. When using in other countries, use a plug adapter (available commercially) as necessary. For more information about plug adapters, consult your travel agency.
- The Charging AC Adapter EH-69P is for charging the battery inserted into the camera. When the camera is connected to an electrical outlet with the Charging AC Adapter, the camera cannot be turned on.
- Do not, under any circumstances, use another make or model of AC adapter other than Charging AC Adapter EH-69P or USB-AC adapter. Failure to observe this precaution could result in overheating or in damage to the camera.

AC Power Source

- If the AC Adapter EH-62G (available separately; 📖 172) is used, power is supplied to the camera from an electrical outlet and taking pictures and playing back images are available with this camera.
- Do not, under any circumstances, use another make or model of AC adapter other than the EH-62G. Failure to observe this precaution could result in overheating or in damage to the camera.

Charging Using Computer or Battery Charger

- Connecting the COOLPIX S4100 to a computer also charges the Rechargeable Li-ion Battery EN-EL19 (📖 134, 161).
- The EN-EL19 can be charged without using the camera by using the Battery Charger MH-66 (available separately; 📖 172).

Turning On and Off the Camera

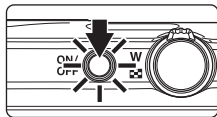

Press the power switch to turn on the camera.

The power-on lamp (green) will light, and then the monitor will turn on (the power-on lamp turns off when the monitor turns on).



To turn off the camera, press the power switch again.





When the camera is turned off, the power-on lamp and the monitor will turn off.

- If the camera is turned off, hold down the  button to turn the camera on in playback mode ( 32).

Power Saving Function (Auto Off)

If no operations are performed for a while, the monitor will turn off, the camera will enter standby mode, and the power-on lamp will blink. If no operations are performed for another three minutes, the camera will turn off automatically.

When the power-on lamp is blinking, pressing any of the following buttons will turn the monitor back on:

- Power switch, shutter-release button,  button,  button, or  (movie-record) button
- In shooting or playback mode, the camera will enter standby mode in about one minute (default setting).
- The time allowed to elapse before the camera enters standby mode can be changed from the **Auto off** option ( 158) in the setup menu ( 146).

Setting Display Language, Date and Time



A language-selection dialog is displayed the first time the camera is turned on.

1 Press the power switch to turn on the camera.

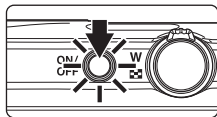
The power-on lamp (green) will light, and then the monitor will turn on (the power-on lamp turns off when the monitor turns on).



2 Tap the desired language.

If the desired language is not displayed, tap  or  to view other language options.

For more information about operating the touch panel, see "Operating the Touch Panel" (📖 8).



3 Tap Yes.

If **No** is tapped, time zone and date will not be set.

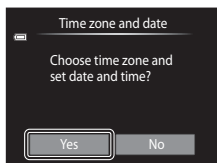



4 Tap or to select your home time zone (📖 151) and tap .

Tap  to return to the previous screen.



Daylight Saving Time

If daylight saving time is in effect, tap  in the time zone selection screen displayed in step 4 to turn on the daylight saving time option.

When the daylight saving time option is enabled,  is displayed at the top of the monitor. To turn off the daylight saving time option, tap  again.



- 5** Tap the order in which the day, month, and year are displayed.

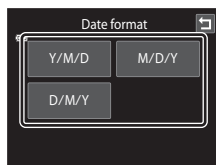

- 6** Edit the date and time.

Tap the desired field and ▲ or ▼ to edit the value.

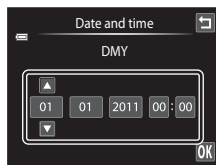

- 7** Tap **OK**.

The settings are applied, the lens extends, and the camera enters shooting mode.

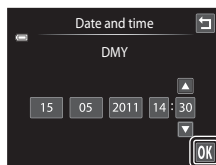

Imprinting and Changing the Date and Time

- To imprint the date on pictures when shooting, enable the **Print date** option (📖 153) in the setup menu (📖 146) after the date and time have been set.
- To change the date and time of the camera clock, select the **Time zone and date** item (📖 149) in the setup menu (📖 146).

Inserting Memory Cards

Image, sound, and movie files are stored in the camera's internal memory (approximately 20 MB) or on removable Secure Digital (SD) memory cards (available commercially;  173).

If a memory card is inserted in the camera, data are automatically stored on the memory card and data recorded to the memory card can be played back, deleted or transferred. Remove the memory card to store data in the internal memory, or play back, delete or transfer data from the internal memory.

- 1 Be sure that the power-on lamp and the monitor are off and open the battery-chamber/memory card slot cover.

Be sure to turn off the camera before opening the cover.

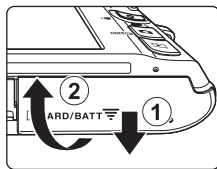

- 2 Insert the memory card.

Slide the memory card in until it clicks into place.

Inserting Memory Cards

Inserting the memory card upside down or backwards could damage the camera or the memory card. Be sure to check that the memory card is in the correct orientation.

Memory card slot

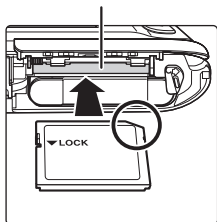

- 3 Close the battery-chamber/memory card slot cover.

Removing Memory Cards

Turn the camera off and be sure that the power-on lamp and the monitor have turned off before opening the battery-chamber/memory card slot cover.

Press the card in (1) to partially eject the card, then remove the card by hand while being careful not to remove the card at an angle (2).

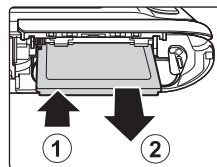

- Note that the camera, battery, and memory card may become hot during use; observe caution when removing the battery or memory card.

✓ Formatting Memory Cards

If the message at right is displayed when the camera is turned on, the memory card must be formatted before use (📖 159). Note that **formatting permanently deletes all pictures and other data on the memory card**. Be sure to make copies of any pictures you wish to keep before formatting the memory card.

Tap **Yes** to format. When the confirmation dialog is displayed, tap **Yes**. To start formatting, tap **OK**.

- Do not turn the camera off or open the battery-chamber/memory card slot cover until formatting is complete.
- Be sure to use this camera to format memory cards previously used in other devices the first time they are inserted into the COOLPIX S4100 (📖 159).

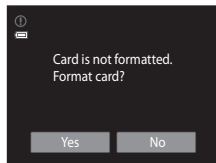

✓ The Write Protect Switch

When the memory card switch is in the "lock" position, data cannot be written to or deleted from the memory card. If the switch is in the "lock" position, unlock it by sliding the switch to the "write" position to record or delete pictures, or to format the memory card.

Write protect switch

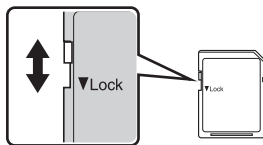

✓ Memory Cards

- Use only Secure Digital memory cards.
- Do not perform the following during formatting, while data is being written to or deleted from the memory card, or during data transfer to a computer. Failure to observe this precaution could result in the loss of data or in damage to the camera or memory card:
 - Take out the battery or memory card
 - Turn off the camera
 - Disconnect the AC adapter
- Do not format the memory card using a computer.
- Do not disassemble or modify.
- Do not drop, bend, or expose to water or strong physical shock.
- Do not touch the metal terminals with your fingers or metal objects.
- Do not affix labels or stickers to the memory card.
- Do not leave in direct sunlight, closed vehicles or areas exposed to high temperatures.
- Do not expose to humidity, dust, or corrosive gases.





Step 1 Turn the Camera On and Select  (Auto) Mode

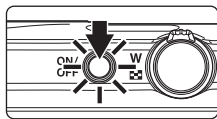

This section describes how to take pictures in  (auto) mode, an automatic, “point-and-shoot” mode recommended for first-time users of digital cameras.

1 Press the power switch to turn on the camera.

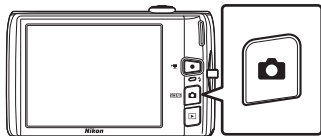
The lens will extend, and the monitor will turn on.

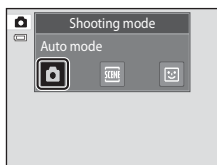
The camera is set to  (auto) mode at the time of purchase. Proceed to step 4.

**2 Press the  button.****3 Tap  in the monitor.****4 Check the battery level indicator and the number of exposures remaining.**

Battery level indicator	Description
	Battery level high.
	Battery level low. Prepare to charge or replace the battery.
 Battery exhausted.	Cannot take pictures. Charge or replace the battery.

Battery level indicator

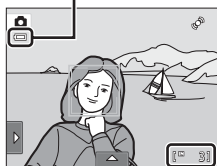

Number of exposures remaining



Number of Exposures Remaining

Indicator is displayed when there are 50 or fewer exposures remaining.

The number of pictures that can be stored depends on the capacity of the internal memory or memory card and image mode setting (📖 44).

Indicators Displayed in (Auto) Mode

Shooting mode

 displayed in  (auto) mode.

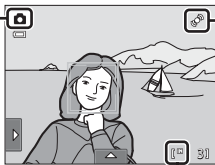



Motion detection icon

The effects of subject movement and camera shake are reduced.

Internal memory indicator

Indicates that images will be stored in the camera's internal memory (approximately 20 MB).

When a memory card is inserted in the camera,  does not appear and images will be stored on the memory card.



When the monitor has turned off in standby mode to save power (the power on lamp is blinking) ( 158), press the following buttons to turn it back on:

- Power switch, shutter-release button,  button or  button

Note on Touch Shutter

At the default setting, the shutter can be released by simply tapping a subject in the monitor ( 45). Take care that you do not release the shutter accidentally.







Functions Available in (Auto) Mode

- When the camera is pointed at a human face, the face detection function, with which the camera automatically detects that face and focuses on it, activates ( 30, 41).
- Shooting settings ( 34, 42) can be changed by tapping the left or bottom tab to display the setting controls.

Motion Detection

See **Motion detection** ( 155) in the setup menu ( 146) for more information.

Electronic Vibration Reduction

When the flash mode ( 34) is set to  (off) or  (slow sync) with **Electronic VR** ( 154) in the setup menu set to **Auto**, the  icon may be displayed in the monitor. When  is displayed, the effects of camera shake may be pronounced under the current shooting conditions. In these situations, the camera reduces the effects of camera shake in pictures before recording them.

Step 2 Frame a Picture

1 Ready the camera.

Hold the camera steadily in both hands, keeping your fingers and other objects away from the lens, flash, AF-assist illuminator, built-in microphone, and speaker.

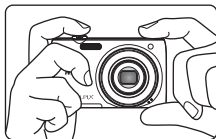

When taking pictures in portrait (“tall”) orientation, turn the camera so that the built-in flash is above the lens.

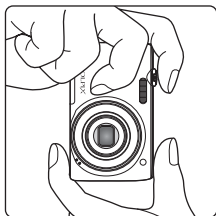

2 Frame the picture.

A face detected by the camera will be framed by a yellow double border (focus area).

Up to 12 faces can be detected. If more than one face is detected, the face closest to the camera will be framed by a double border, and the others by a single border.

When taking pictures of subjects other than people, or framing a subject with which no face is detected, a focus area will not be displayed. Frame the picture so that the intended subject is at or near the center of the frame.



Using the Zoom

Rotate the zoom control to activate optical zoom. To zoom in so that the subject fills a larger area of the frame, rotate to **T**. To zoom out so that the area visible in the frame increases, rotate to **W**.

- The zoom position is set at the maximum wide-angle position when the camera is turned on.
- A zoom indicator is displayed at the top of the monitor when the zoom control is rotated.

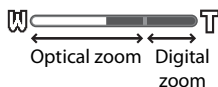
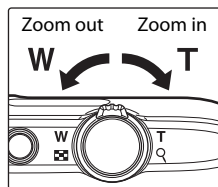

Digital Zoom

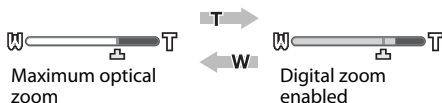

When the camera is zoomed in to the maximum optical zoom position, rotating and holding the zoom control at **T** triggers digital zoom. The subject is magnified up to 4× the maximum optical zoom ratio.



- The camera focuses at the center of the frame and the focus area is not displayed when digital zoom is in effect.

Digital Zoom and Interpolation

Unlike optical zoom, digital zoom uses a digital imaging process known as interpolation to magnify images, resulting in slight deterioration of picture quality according to the image mode (📖 43) and digital zoom magnification.

Interpolation is applied at zoom positions beyond  when taking still pictures. When zoom is increased beyond the  position, interpolation is initiated and the zoom indicator turns yellow to indicate that interpolation is being applied. The position of  moves to the right as image size decreases, allowing for confirmation of the zoom positions at which shooting without interpolation is possible at the current image mode setting.



- Digital zoom can be disabled from the **Digital zoom** option (📖 156) in the setup menu (📖 146).

Step 3 Focus and Shoot

1 Press the shutter-release button halfway.

When the shutter-release button is pressed halfway (📖 7), the camera sets focus and exposure (shutter speed and aperture value). Focus and exposure remain locked while the shutter-release button is pressed halfway.

When a face is detected, it is framed by the double border indicating the active focus area. When the subject is in focus, the double border turns green.

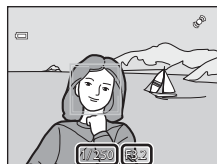
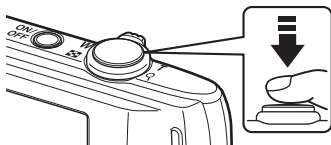

Shutter speed Aperture value

When a face is not detected, the camera automatically selects one (or more) of the nine focus areas containing the subject closest to the camera. When focus is set, the active focus area (up to nine areas) turns green.

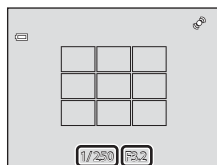

Shutter speed Aperture value

When digital zoom is used, the focus area is not displayed and the camera focuses at the center of the frame. Once focus has been acquired, the focus indicator will glow green.

If the focus area or the focus indicator blinks red when the shutter-release button is pressed halfway, the camera is unable to focus. Modify the composition and press the shutter-release button halfway again.

Focus indicator



2 Press the shutter-release button the rest of the way down.

The shutter is released and the picture will be recorded to the memory card or internal memory.



✔ During Recording

While pictures are being recorded, the number of exposures remaining will blink. **Do not open the battery-chamber/memory card slot cover** while pictures are being recorded. Cutting power or removing the memory card in these circumstances could result in loss of data or in damage to the camera or card.

✔ Autofocus

Autofocus may not perform as expected in the following situations. In some rare cases, the subject may not be in focus despite the fact that the focus area or the focus indicator glows green.

- Subject is very dark
- Objects of sharply differing brightness are included in the scene (e.g. the sun behind the subject makes that subject appear very dark)
- No contrast between the subject and surroundings (e.g. a portrait subject, wearing a white shirt, is standing in front of a white wall)
- Several objects are at different distances from the camera (e.g. the subject is inside a cage)
- Regular geometric patterns (e.g. window blind or windows in a skyscraper)
- Subject is moving rapidly

In the situations noted above, try pressing the shutter-release button halfway to refocus several times, or focus on another subject (📖 52). When focusing on another subject, be sure that the alternate subject is at the same distance from the camera as the intended subject while the shutter-release button is pressed halfway.

✔ When the Subject Is Close to the Camera

If the camera cannot focus, try shooting with macro mode (📖 38) or in the **Close-up** scene mode (📖 67).

✔ Note on Face Detection

See “Notes on the Face Detection Function” (📖 41) for more information.

✎ Touch Shutter

At the default setting, the shutter can be released by simply tapping a subject in the monitor (📖 45) without pressing the shutter-release button. The **Touch shutter** option can be changed to the **Touch AF/AE** option, which allows the camera to set the focus and exposure on the subject that is tapped on the monitor. When using the **Touch AF/AE** option, the picture is taken by pressing the shutter-release button (📖 50).

🔦 AF-assist Illuminator and Flash

If the subject is poorly lit, the AF-assist illuminator (📖 156) may light up when the shutter-release button is pressed halfway, or the flash (📖 34) may fire when the shutter-release button is pressed all the way down.



Step 4 Playing Back and Deleting Pictures

Playing Back Pictures (Playback Mode)

Press the  (playback) button.

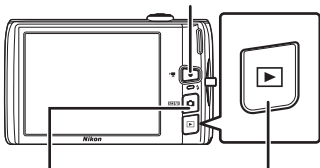
● ( movie-record) button



 (shooting mode) button  (playback) button Internal memory indicator

The last picture taken will be displayed in full-frame playback mode.

Drag the current picture left or right to display the previous or next picture. Drag your finger quickly across half of the monitor or more to skip past the previous or next five pictures. Tap the monitor to stop at a picture as it slides past.

Display the previous picture

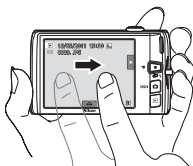

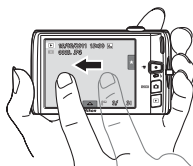

Display the next picture



Pictures may be displayed briefly at low resolution while being read from the memory card or internal memory.

Press the  button or shutter-release button to switch to shooting mode. Pressing the ● ( movie-record) button will also return the camera to shooting mode.

When playing back pictures stored in the camera's internal memory,  is displayed. When a memory card is inserted in the camera,  is not displayed and images stored on the memory card are played back.

When the Monitor Has Turned Off to Save Power

When the power-on lamp is blinking, press the  button to turn the monitor back on ( 158).





Operations Available in Playback Mode

See "More on Playback" ( 80) or "Editing Pictures" ( 110) for more information.

Pressing the Button to Turn On the Camera

When the camera is off, holding down the  button will turn the camera on in playback mode. The lens will not extend.

Viewing Pictures

Pictures taken using face detection ( 41) or pet detection ( 70) will be rotated and displayed automatically in full-frame playback mode, based on the orientation of the faces detected, except pictures taken using **Continuous**, **BSS**, and **Multi-shot 16** ( 54, 70), or the subject tracking function ( 48).

Deleting Unwanted Pictures

- 1 Play back a picture to be deleted, tap the bottom tab to display the setting controls (📖 14), and tap 🗑️.



- 2 Tap the desired delete option.

Current image: Delete the currently displayed full-frame picture or movie (📖 131).

Erase selected images: Select multiple pictures and delete them. See “Operating the Erase Selected Images Screen” for more information.

All images: Delete all pictures.

If step 1 is performed in thumbnail playback mode (📖 81), select either **Erase selected images** or **All images**.

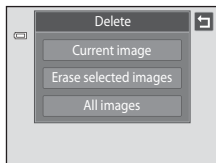

- 3 Tap **Yes** on the delete confirmation dialog.

Deleted pictures cannot be recovered.

To exit without deleting the picture, tap **No** or **No**.

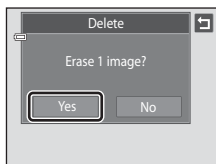

Operating the Erase Selected Images Screen

- 1 Tap a picture to display ♥️.

To deselect the picture, tap the picture again and ♥️ will be hidden.

Tap ⏮️ or ⏭️ to display the previous or next page.

Tap 🔍 or 🔍, or rotate the zoom control to T (🔍) or W (🔍) (📖) to change the number of pictures displayed.



- 2 Display ♥️ to all pictures to delete and tap **OK** to apply the selection.

The confirmation screen is displayed. Follow the onscreen instructions for more operations.

✓ Notes on Deletion

- Once deleted, pictures cannot be recovered. Transfer important pictures to a computer before deleting them.
- Protected pictures cannot be deleted (📖 101).

Using the Basic Shooting Functions

⚡ Flash Mode

Flash mode can be selected to suit the shooting conditions.

- When **ISO sensitivity** is set to **Auto**, the flash has a range of 0.5–4.5 m (1 ft. 8 in.–14 ft.) at the maximum wide-angle zoom position and a range of 0.5–2.2 m (1 ft. 8 in.–7 ft. 3 in.) at the maximum telephoto zoom position.



Auto

Flash fires automatically when lighting is poor.



Auto with red-eye reduction

Reduce “red-eye” in portraits (📖 35).



Off

Flash will not fire even when lighting is poor.



Fill flash

Flash fires whenever a picture is taken. Use to “fill-in” (illuminate) shadows and backlit subjects.



Slow sync

⚡ (auto) is combined with slow shutter speed.
Suited to evening and night portraits that include background scenery.
Flash illuminates main subject; slow shutter speeds are used to capture background at night or under dim lighting.

Setting the Flash Mode

- 1 Tap the left tab to display the setting controls (📖 14) and tap the flash mode icon.



- 2 Tap the desired flash mode icon.

Tap 🏠 to return to the previous screen.

To hide the setting controls after applying the setting, tap the tab again.

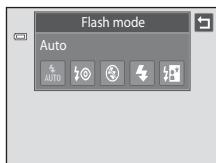

✓ Shooting When the Flash is Disabled (🚫) or Lighting is Dim

- Use of a tripod is recommended.
- The noise reduction function may be activated with some shooting conditions such as dim lighting. More time than usual is required to record pictures to which noise reduction is applied.

✓ Note on Using the Flash

When using the flash, reflections from dust particles in the air may appear as bright spots in pictures. To reduce these reflections, set the flash to 🚫 (off).

📎 The Flash Lamp

The flash lamp indicates flash status when the shutter-release button is pressed halfway.

- On: Flash will fire when picture is taken.
- Blinks: Flash charging. Wait a few seconds and try again.
- Off: Flash will not fire when picture is taken.

If the battery is low, the monitor display will turn off, and remain off, until the flash is fully charged.

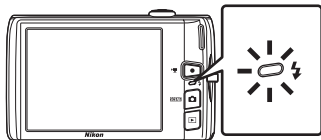

📎 The Flash Mode Setting

The default flash mode setting varies with shooting mode.

- 📷 (auto) mode: 🔄 (auto)
- Scene: varies with the selected scene mode (📖 59)
- 😊 (smart portrait): fixed at 🔄 (auto) when **Off** is selected for **Blink proof**, 🚫 (off) when **On** is selected for **Blink proof** (📖 77)

There are functions with which the flash cannot be enabled. See "Camera Settings that Cannot Be Applied Simultaneously" (📖 78) for more information.

The flash mode setting applied in 📷 (auto) mode is stored in the camera's memory even after the camera is turned off.

📎 Red-eye Reduction

This camera uses advanced red-eye reduction ("In-Camera Red-Eye Fix").

If the camera detects red-eye when a picture is taken, the affected area is processed to reduce red-eye before the picture is saved.

Note the following when shooting:

- More time than usual is required to record pictures.
- Red-eye reduction may not produce the desired results in some situations.
- In extremely rare instances, areas not subject to red-eye may be affected by red-eye reduction processing; in these cases, choose another flash mode and try again.

🕒 Taking Pictures with the Self-timer

The camera is equipped with a ten-second and two-second timer for self-portraits. This feature is useful for reducing the effects of camera shake that occurs when pressing the shutter-release button. When using the self-timer, use of a tripod is recommended.

- 1 Tap the left tab to display the setting controls (📖 14) and tap the self-timer icon.



- 2 Tap **10s** or **2s**.

10s (ten seconds): Use on important occasions, such as weddings

2s (two seconds): Use to prevent camera shake

The mode selected for self-timer is displayed.

Tap 📖 to return to the previous screen.

To hide the setting controls after applying the setting, tap the tab again.

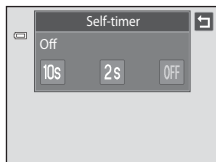

- 3 Frame the picture and press the shutter-release button halfway.

Focus and exposure will be set.

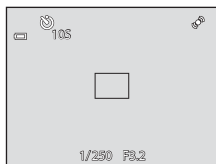

4 Press the shutter-release button the rest of the way down.

The self-timer starts, and the number of seconds remaining before the shutter is released is displayed in the monitor. The self-timer lamp blinks while the timer is counting down. About one second before the shutter is released, the lamp stops blinking and glows steadily.

When the shutter is released, the self-timer will be set to **Off**.

To stop the timer before a picture is taken, press the shutter-release button again.

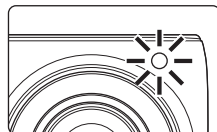
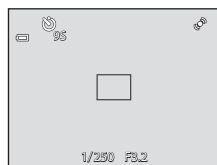

Note on Self-timer

There are functions with which this setting cannot be enabled. See “Camera Settings that Cannot Be Applied Simultaneously” ( 78) for more information.

Macro Mode

Macro mode is used for taking pictures of objects as close as 10 cm (4 in.). Note that the flash may be unable to light the entire subject at distances of less than 50 cm (1 ft. 8 in.).

- 1 Tap the left tab to display the setting controls ( 14) and tap the macro mode icon.

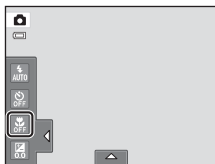



- 2 Tap **ON**.

Tap  to return to the previous screen.

To hide the setting controls after applying the setting, tap the tab again.



- 3 Rotate the zoom control to frame the picture.

The closest possible shooting distance may vary according to the zoom position. The camera can focus at a closer distance when  and the zoom indicator glow green and the zoom indicator is positioned to the left of  (wide-angle position).

The camera can focus on subjects as close as 10 cm (4 in.) to the lens when zoomed out to the maximum wide-angle position or when zoomed in one step from the maximum wide-angle zoom position. At the  zoom position, the camera can focus at a distance of 30 cm (1 ft.).

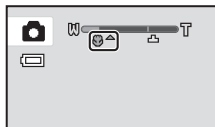

Note on Macro Mode Setting

There are functions with which this setting cannot be enabled. See “Camera Settings that Cannot Be Applied Simultaneously” ( 78) for more information.

Autofocus

When taking still pictures in macro mode, the camera continuously adjusts the focus until the shutter-release button is pressed halfway to lock the focus. Therefore, the sound of lens focus motor can be heard.

The Macro Mode Setting

The macro mode setting applied in  (auto) mode is stored in the camera's memory even after the camera is turned off.

Changing the Brightness Using Exposure Compensation

Exposure compensation is used to alter exposure from the value suggested by the camera to make pictures brighter or darker.

- 1 Tap the left tab to display the setting controls ( 14) and tap the exposure compensation icon.

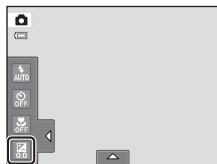

- 2 Drag the slider to change the exposure compensation value.

To make the picture brighter, apply positive (+) exposure compensation.

To make the picture darker, apply negative (-) exposure compensation.

Tap  to return to the previous screen.

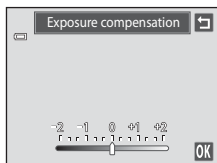

- 3 Tap .

To hide the setting controls after applying the setting, tap the tab again.

To cancel the exposure compensation, return to step 1, revert the value to **0**, and tap .

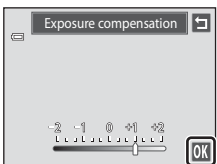

Exposure Compensation Value

The exposure compensation value applied in  (auto) mode is stored in the camera's memory even after the camera is turned off.

Selecting a Shooting Mode

Following shooting modes can be selected.

Auto mode 📖 26

Pictures can be taken with an automatic, “point-and-shoot” mode recommended for first-time users of digital cameras. The flash mode and macro mode settings can be changed, and other settings are available, such as the continuous setting or the “subject tracking” option, which moves the active focus area to track the registered subject.

Scene mode 📖 58

Camera settings are automatically optimized for the selected scene. In scene auto selector mode, the camera automatically selects the optimum scene mode for simpler shooting.

Smart portrait mode 📖 74

The camera uses the face detection function to detect human faces, and automatically releases the shutter when a smile is detected. The skin softening option can be used to make skin tones of human faces displayed smoothly.

1 Press the button in shooting mode.

The shooting-mode selection menu is displayed.

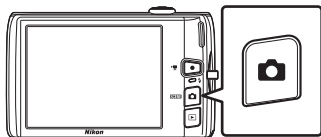

2 Tap the desired shooting mode icon.

The camera enters the selected shooting mode.

To select a scene mode, first tap  (scene), and then tap the icon of the desired scene mode (📖 58).

To return to the current shooting mode without switching shooting modes, press the  button or the shutter-release button.

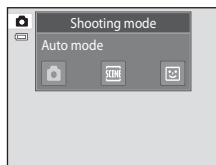

Face Detection

When the camera is pointed at a human face in the shooting modes listed below, the camera automatically detects the face and focuses on it. When the camera detects more than one face, the double border (focus area) is displayed around the face that is focused on, and single borders around the others.



Shooting mode	Number of faces that can be detected	Focus area (double border)
(auto) mode (📖 26) Scene auto selector, Portrait, Night portrait scene mode (📖 58)	Up to 12	The face closest to the camera
Smart portrait mode (📖 74)	Up to 3	The face closest to the center of the frame

- In (auto) mode, if no faces are detected when the shutter-release button is pressed halfway, the camera automatically selects one (or more) of the nine focus areas containing the subject closest to the camera.
- In **Scene auto selector** scene mode, the focus area changes depending on the selected scene.
- In **Portrait** and **Night portrait** scene modes or smart portrait mode, if no faces are detected when the shutter-release button is pressed halfway, the camera will focus on the subject at the center of the frame.
- Tap a face framed by a single border to change the focus area to that face (📖 45, 50).
- In subject tracking mode, subject tracking begins when a detected face framed by a border is tapped (📖 48).

✔ Notes on the Face Detection Function

- The camera may be unable to detect faces in the following situations:
 - When faces are partially hidden by sunglasses or other obstructions
 - When faces take up too much or too little of the frame
- When the frame includes more than one face, the faces detected by the camera and the face on which the camera focuses depend upon a variety of factors, including the direction in which the faces are looking.
- In some cases, including those noted in "Autofocus" (📖 31), autofocus may not perform as expected, and the subject may not be in focus despite the fact that the double border glows green. Should this occur, refocus on another subject positioned at the same distance from the camera as the actual portrait subject (📖 52).

📎 Notes on Pictures Including Detected Faces

- When pictures in which a face was detected during shooting are played back, the pictures will be automatically rotated for playback display according to the orientation of the face detected except pictures that were taken using **Continuous**, **BSS**, and **Multi-shot 16** (📖 54), or the subject tracking function (📖 48).
- In full-frame playback mode, the picture will be enlarged with the face detected during shooting at the center of the monitor when the zoom control is rotated to **T** (📖 84) except pictures that were taken using **Continuous**, **BSS**, and **Multi-shot 16** (📖 54), or the subject tracking function (📖 48).







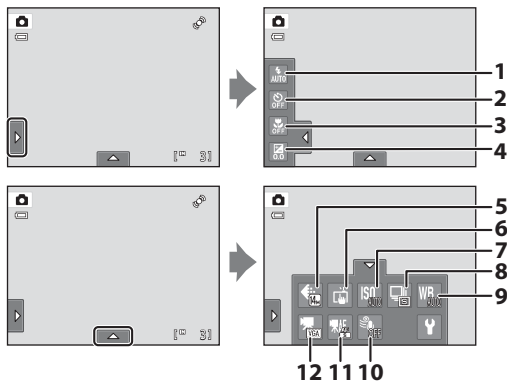

Adjusting the (Auto) Mode setting







In  (auto) mode, the camera settings indicated below can be adjusted by tapping the tabs to display the setting controls.

- Each icon also indicates the current setting.
- Tap the icon of the desired item to display the setting screen for that item.
- Tap the tab again to hide the setting controls.

In  (auto) mode, the settings are stored in the camera's memory even after the camera is turned off (except the self-timer setting).



1		Flash mode ¹	34
2		Self-timer ¹	36
3		Macro mode ²	38
4		Exposure compensation ¹	39
5		Image mode ¹	43
6	Touch shooting		
		Touch shutter ¹	45
		Subject tracking	48
		Touch AF/AE ¹	50

7		ISO ISO sensitivity	53
8		Continuous	54
9		White balance	55
10		Wind noise reduction ¹	130
11		Movie AF mode ¹	129
12		Movie options ¹	128

¹ The settings can be adjusted in some scene modes (📖 59) and in smart portrait mode (📖 76).

² The settings can be adjusted in some scene modes (📖 59).

Camera Settings that Cannot Be Applied Simultaneously

Some shooting settings cannot be used with other functions. See “Camera Settings that Cannot Be Applied Simultaneously” (📖 78) for more information.

Image Mode (Changing Image Quality/Image Size)

 (auto) → Tap the bottom tab →  Image mode

Image mode refers to the combination of image size and image quality (compression) at which pictures are recorded. Choose the image mode best suited to the manner in which pictures will be used and the capacity of the internal memory or memory card. The higher the image mode setting, the larger the size at which it can be printed or displayed without appearing noticeably “grainy,” but limiting the number of pictures that can be recorded.























Option	Size (pixels)	Description
 4320×3240★	4320 × 3240	Higher quality than  , suitable for enlargements or high-quality prints. The compression ratio is approximately 1:4.
 4320×3240 (default setting)	4320 × 3240	Best choice in most situations. The compression ratio is approximately 1:8.
 3264×2448	3264 × 2448	
 2592×1944	2592 × 1944	
 2048×1536	2048 × 1536	Smaller size than  ,  , or  allows more pictures to be stored. The compression ratio is approximately 1:8.
 1024×768	1024 × 768	Suited to display on a computer monitor. The compression ratio is approximately 1:8.
 640×480	640 × 480	Suited to full-screen display on a television with an aspect ratio of 4:3, or distribution by e-mail. The compression ratio is approximately 1:8.
 4224×2376	4224 × 2376	Pictures with an aspect ratio of 16:9 are recorded. The compression ratio is approximately 1:8.

Image Mode

- The setting can also be changed in shooting modes other than  (auto) mode by tapping the bottom tab to display the setting controls and then tapping the  button.
- Changes made to the image mode setting are applied to all shooting modes.
- There are functions with which this setting cannot be enabled. See “Camera Settings that Cannot Be Applied Simultaneously” ( 78) for more information.

 **Number of Exposures Remaining**





The following table lists the approximate number of pictures that can be stored in internal memory and on a 4 GB memory card. Note that the number of pictures that can be stored will differ depending on the composition of the picture (due to JPEG compression). In addition, this number may vary depending on the make of memory card, even when the memory cards have the same specified capacity.

Setting	Internal memory (approx. 20 MB)	Memory card (4 GB)	Print size* (cm/in.)
 4320×3240★	1	430	36 × 27/14 × 10.5
 4320×3240	3	860	36 × 27/14 × 10.5
 3264×2448	6	1570	28 × 21/11 × 8
 2592×1944	11	2560	22 × 16/8.5 × 6.5
 2048×1536	18	4230	17 × 13/7 × 5
 1024×768	44	12300	9 × 7/3.5 × 2.5
 640×480	74	23800	5 × 4/2 × 1.5
 4224×2376	5	1210	35 × 20/14 × 8

* Print size at an output resolution of 300 dpi. Print sizes are calculated by dividing the number of pixels by printer resolution (dpi) and multiplying by 2.54 cm (1 in.). However, at the same image size, pictures printed at higher resolutions will print smaller than the size indicated, and those printed at lower resolutions will print larger than the size indicated.





- The number of exposures remaining is displayed on the shooting screen when 50 or fewer remain ( 26).
- If there are 10,000 or more pictures saved in the camera, "9999" is displayed on the playback screen as the current frame number or total number of frames.

Touch Shutter (Tapping the Monitor to Release the Shutter)

 (auto) → Tap the bottom tab →  /  /  Touch shooting

Pictures can be taken by simply tapping the monitor.

- **Touch shutter** is set by default. Proceed to step 2.

- 1 Tap the bottom tab, tap  /  /  (touch shooting) (📖 42), then tap  (touch shutter).

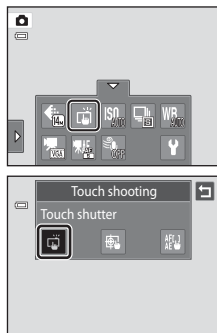



- 2 Tap the desired subject to take a picture.

Do not use force when tapping the monitor as this may cause slight movement of the camera, resulting in blurred pictures.





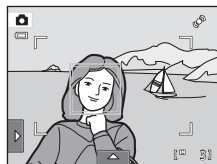
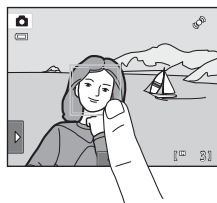

When digital zoom is in effect, the camera focuses on the subject in the center of the frame.

The shutter-release button can also be used when the touch shutter option is selected.

If  is displayed when the monitor is tapped, the shutter cannot be released. Tap an area within  or a border displayed when the camera detects a face.



Notes on Touch Shutter

- When taking pictures with **Continuous** or **BSS** in **Continuous** setting ( 54) enabled, or in **Sports** or **Museum** scene mode ( 58), use the shutter-release button to take pictures. Only one picture can be taken at a time using the touch shutter function.
- Prevent shooting with accidental tapping of the monitor in  (auto) mode and some scene modes by changing the touch shooting setting to **Touch AF/AE** ( 50). At this setting, the shutter is not released when the monitor is tapped.
- When shooting subjects with which autofocus may not perform as expected, the subject may not be in focus ( 31).
- When a subject displayed in the monitor is tapped with the self-timer ( 36) enabled, the camera locks focus and releases the shutter after ten or two seconds.
- There are functions with which this setting cannot be enabled. See “Camera Settings that Cannot Be Applied Simultaneously” ( 78) for more information.

 **Shooting Modes That Support Touch Shutter**

The touch shutter can be used in  (auto) mode and other shooting modes. Touch shutter operation differs according to the current shooting mode as follows.

Shooting mode	Touch shutter operation
 (auto) mode (📖 26), Sports, Party/indoor, Beach, Snow, Close-up, Food, Museum, Black and white copy, and Backlighting scene modes (📖 58)	Tap the intended subject. Focus and exposure are set for the area tapped. When the camera detects more than one face, tap a face framed by a single border to set focus and exposure for that face.
Scene auto selector scene mode (📖 58) and smart portrait mode (when Smile timer is set to Off ; 📖 74)	<ul style="list-style-type: none"> • When the camera detects any faces, tap a face framed by a border. Focus and exposure are set on the tapped face. • When no face is detected, the camera focuses at the area tapped.
Portrait and Night portrait scene modes (📖 58)	Only a border displayed by the face detection function can be selected. When the camera detects more than one face, tap a face framed by a single border to set focus and exposure for that face.
Landscape, Sunset, Dusk/dawn, Night landscape, Fireworks show, and Panorama assist scene modes (📖 58)	Focus and exposure are set for the same focus area used when pictures are taken by pressing the shutter-release button. See “Selecting a Scene Mode to Take Pictures (Features)” (📖 63) for more information.
Smart portrait mode (when Smile timer is set to On ; 📖 74)	Touch shutter cannot be enabled. When the camera detects more than one face, tap a face framed by a single border to move the focus area to that face.
Pet portrait scene mode (📖 58)	Tap the intended subject. Focus and exposure are set for the area tapped. However, if Pet portrait auto release is set to On and the camera detects any pet faces, the camera automatically focuses on the detected faces and releases the shutter.

Subject Tracking (Focusing on a Moving Subject)

(auto) → Tap the bottom tab → / / Touch shooting

In (auto) mode (📖 26), the touch shooting setting can be changed from **Touch shutter** (default setting) to **Subject tracking**. Use this option to take pictures of moving subjects. Tap the subject on which the camera will focus. The focus area will automatically move to track the subject.

- 1 Tap the bottom tab, tap / / (touch shooting) (📖 42), then tap (subject tracking).

(subject tracking) is enabled only in (auto) mode.



- 2 Register a subject.

Tap the desired tracking subject in the monitor.

- The subject is registered.
- When the camera detects any faces, tap a face framed by a border to register it as the subject and begin tracking. If the camera detects more than one face, the borders around the faces that are not selected disappear.
- When a subject other than a face is registered, a yellow focus area is displayed on the subject and the camera begins tracking the subject.
- When the border framing the subject glows red, the camera is unable to focus. Change the composition and try again.

If the tapped area does not contain a subject that can be registered, is displayed in the monitor. Tap a subject within .

Tap another subject to change a subject to follow.

To cancel the registration of the subject, tap displayed at left in the monitor.

If the camera cannot track the registered subject anymore, the focus area will disappear and the registration will be canceled. Register the subject again.

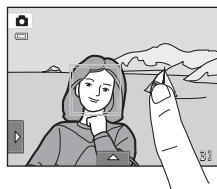

3 Press the shutter-release button to take a picture.

The camera focuses on the focus area when the shutter-release button is pressed halfway. The focus area will glow green and focus will be locked.





When the camera is unable to focus, the focus area will blink. Press the shutter-release button halfway again to focus.

If the shutter-release button is pressed halfway while the focus area is not displayed, the camera focuses on the subject at the center of the frame.

Press the shutter-release button all the way down to release the shutter.







Notes on Subject Tracking Mode

- Digital zoom is not available.
- The sound of the lens focus motor can be heard when the subject tracking function is working.
- Adjust zoom position and apply shooting settings ( 42) before registering the subject. If these settings are adjusted after the subject has been registered, subject registration will be canceled.
- It may be impossible to register the desired subject, or the camera may be unable to track the registered subject or may begin tracking a different subject, if the subject is moving rapidly, if there is a significant amount of camera shake, or if the camera detects a similar subject. The camera's ability to accurately track the registered subject is also dependent upon the size and brightness of the subject.
- In some rare cases, subjects with which autofocus may not perform as expected ( 31) may be out of focus despite the fact that the focus area glows green. In this situation, focus on another subject which is at the same distance from the camera as the intended subject while the shutter-release button is pressed halfway ( 52).
- There are functions with which this setting cannot be enabled. See "Camera Settings that Cannot Be Applied Simultaneously" ( 78) for more information.

Touch Shooting Setting





Subject registration with subject tracking will be canceled when the camera is turned off.

Touch AF/AE (Tapping the Monitor to Focus)

 (auto) → Tap the bottom tab → //AF/AF-AE  Touch shooting



The touch shooting setting can be changed from **Touch shutter** (default setting) to **Touch AF/AE**.

Tap a subject in the monitor to select the area at which the camera focuses. Press the shutter-release button halfway to lock focus and exposure for the area tapped, and press the shutter-release button the rest of the way down to take the picture.

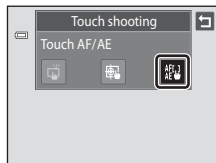
- 1 Tap the bottom tab, tap //AF/AF-AE  (touch shooting) (📖 42), then tap /AF/AF-AE  (touch AF/AE).







- 2 Tap the subject at which the camera focuses.

  or a double border will be displayed at the area tapped.

When digital zoom is applied, the focus area cannot be selected.

To cancel the focus area selection, tap  displayed at left in the monitor.

If a position at which focus cannot be acquired is tapped,   will be displayed in the monitor. Tap another position inside  .

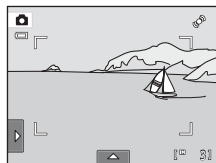
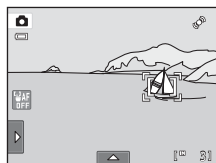

3 Press the shutter-release button to take a picture.

Press the shutter-release button halfway to acquire focus and exposure and press it all the way down to release the shutter.













Note on Touch AF/AE

When shooting subjects with which autofocus may not perform as expected, the subject may not be in focus ( 31).



Shooting Modes That Enable Touch AF/AE Function

Touch AF/AE can be used in  (auto) mode and other shooting modes. Touch AF/AE operation differs according to the current shooting mode as follows.

Shooting mode	Touch AF/AE operation
 (auto) mode ( 26), Sports, Party/indoor, Beach, Snow, Close-up, Food, Museum, Black and white copy, and Backlighting scene modes ( 58)	Focus and exposure are set for the area tapped.
Scene auto selector scene mode ( 58) and smart portrait mode (when Smile timer is set to Off ;  74)	<ul style="list-style-type: none"> When the camera detects a face, only a face framed by a border can be selected. When the camera detects more than one face, tap a face framed by a single border to move the focus area to that face. When no face is detected, the camera focuses at the area tapped.
Portrait and Night portrait scene modes ( 58), and smart portrait mode (when Smile timer is set to On ;  74)	Only a border displayed by the face detection function can be selected. When the camera detects more than one face, tap a face framed by a single border to move the focus area to that face.
Landscape, Sunset, Dusk/dawn, Night landscape, Fireworks show, and Panorama assist scene modes ( 58)	Focus area cannot be changed.
Pet portrait scene mode ( 58)	Touch shutter (default setting) or touch AF/AE can be selected when Pet portrait auto release ( 70) is set to Off . When touch AF/AE is enabled, focus and exposure are set for the area tapped. However, if Pet portrait auto release is set to On while touch AF/AE is already enabled, and the camera detects any pet faces, the camera automatically focuses on the detected faces and releases the shutter.

Taking Pictures of Subjects with Which Autofocus may not Perform as Expected

When taking pictures of subjects with which autofocus may not perform as expected ( 31), try pressing the shutter-release button halfway to refocus several times, or try the following techniques.

- 1 Switch to  (auto) mode ( 26) and select **Touch AF/AE** for the touch shooting setting.

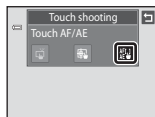

- 2 Tap another subject that is as far from the camera as the desired subject.

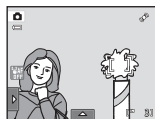

- 3 Press the shutter-release button halfway.

- The camera focuses on the subject and the focus area glows green.
- Exposure is locked for the subject on which focus is acquired when the shutter-release button is pressed halfway.

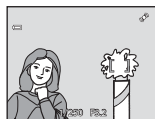

- 4 Continue holding down the shutter-release button halfway and recompose the picture.

- Be sure to maintain the same distance between the camera and the subject while the shutter-release button is pressed halfway.



- 5 Press the shutter-release button the rest of the way down to take the picture.



ISO ISO Sensitivity

 (auto) → Tap the bottom tab → **ISO** ISO sensitivity

The higher the sensitivity, the less light is needed to expose an image, allowing capturing darker subjects.

Also, a higher sensitivity allows higher shutter speeds, resulting in the picture with less camera shake and subject blur in comparison to the same subject taken under the same brightness.

- Although high ISO sensitivity settings are suited to pictures of subjects taken under dim lighting, those taken without flash, or those taken at telephoto setting, high sensitivity settings are often associated with “noise”- randomly spaced, brightly colored pixels- concentrated in dark portions of images.

AUTO Auto (default setting)

Sensitivity is ISO 80 under normal conditions; when lighting is poor, the camera compensates by raising sensitivity to a maximum of ISO 1600.



Fixed range auto

Choose the range in which the camera automatically adjusts ISO sensitivity, from **ISO 80-400** or **ISO 80-800**. The camera will not increase sensitivity beyond the maximum value in the selected range. Set the maximum value for ISO sensitivity for effective control over the amount of “grain” that appears in images.

80, 100, 200, 400, 800, 1600, 3200

Sensitivity is locked at the specified value.

Notes on ISO Sensitivity

- There are functions with which this setting cannot be enabled. See “Camera Settings that Cannot Be Applied Simultaneously” ( 78) for more information.
- When the ISO sensitivity setting is set to any option other than **Auto, Motion detection** ( 155) is disabled.

📷 Continuous

📷 (auto) → Tap the bottom tab → 📷 Continuous

Enable continuous shooting or BSS (best shot selector).

📷 Single (default setting)

One picture is taken each time the shutter-release button is pressed.

📷 Continuous

While the shutter-release button is held down, up to three pictures are taken at a rate of about 0.7 frames per second (at an **Image mode** setting of 📷 **4320×3240**).

📷 BSS (Best Shot Selector)

The “best shot selector” is recommended when shooting with the flash off or the camera zoomed in, or in other situations in which inadvertent motion can result in blurred pictures. When BSS is on, the camera takes up to ten pictures while the shutter-release button is held down. The sharpest picture in the series is automatically selected and saved.

📷 Multi-shot 16

Each time the shutter-release button is pressed, the camera takes 16 shots at a rate of about 30 fps and arranges them in a single image.

Pictures are recorded at an image mode setting of 📷 (image size: 2560 × 1920 pixels). This setting cannot be changed. Digital zoom is not available.

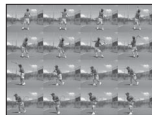

✔ Notes on Continuous Shooting

- When **Continuous**, **BSS**, or **Multi-shot 16** is selected, the flash is disabled. Focus, exposure, and white balance are fixed at the values determined with the first picture in each series.
- The frame rate with continuous shooting may vary depending upon the current image mode setting, the memory card used, or shooting condition.
- There are functions with which this setting cannot be enabled. See “Camera Settings that Cannot Be Applied Simultaneously” (📖 78) for more information.

✔ Note on BSS

BSS is effective when taking pictures of still subjects. BSS may not produce the desired results if the subject moves or the composition changes while the shutter-release button is held down.

✔ Note on Multi-shot 16

Smear (📖 171) visible in the monitor when shooting with **Multi-shot 16** enabled will be recorded with images. Avoiding bright objects such as the sun, reflections of the sun, and electric lights when shooting with **Multi-shot 16** enabled is recommended.

WB White Balance (Adjusting Hue)

 (auto) → Tap the bottom tab → WB White balance

The color of light reflected from an object varies with the color of the light source. The human brain is able to adapt to changes in the color of the light source, with the result that white objects appear white whether seen in the shade, direct sunlight, or under incandescent lighting. Digital cameras can mimic this adjustment by processing images according to the color of the light source. This is known as “white balance.” For natural colors, choose a white balance setting that matches the light source before shooting. Although the default setting, **Auto**, can be used under most types of lighting, the white balance setting suited to a particular light source can be specified manually to achieve more accurate results.

AUTO Auto (default setting)

White balance automatically adjusted to suit lighting conditions. Best choice in most situations.

PRE Preset manual

Neutral-colored object used as reference to set white balance under unusual lighting conditions. See “Preset Manual” ( 56) for more information.

Daylight

White balance adjusted for direct sunlight.

Incandescent

Use under incandescent lighting.

Fluorescent

Use under fluorescent lighting.

Cloudy

Use when taking pictures under overcast skies.

Flash

Use with the flash.

Note on White Balance

At white-balance settings other than **Auto** or **Flash**, turn the flash off (  34).

 **Note on Preset Manual**

A value for flash lighting cannot be measured with **Preset manual**. When shooting using the flash, set **White balance** to **Auto** or **Flash**.

Shooting Suited to Scenes (Scene Mode)

Camera settings are automatically optimized for the selected subject type. The following scene modes are available.

Scene auto selector	Portrait	Landscape	Sports
Night portrait	Party/indoor	Beach	Snow
Sunset	Dusk/dawn	Night landscape	Close-up
Food	Museum	Fireworks show	Black and white copy
Draw	Backlighting	Panorama assist	Pet portrait

Selecting a Scene Mode

- 1 Press the button in shooting mode and tap .

The scene mode selection screen is displayed.

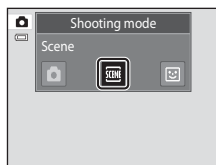

- 2 Tap the desired scene icon.

The display changes to that for the selected scene mode.

For more information about features of scene modes, see page 63.



- 3 Frame the subject and take a picture.

The degree of effects can be adjusted with the scene effect adjustment slider (60) depending on the scene mode.



Displaying a Description of Each Scene Mode (Help Display)



































































When is tapped in the scene selection screen (step 2), the help selection screen is displayed. Tap a scene icon to display a description of the features of that mode. Tap to return to the help selection screen.

- Tap in the help selection screen to return to the monitor display shown in step 2.



Shooting Settings in Scene Mode

The shooting settings for each scene mode are shown below.

	Flash mode ( 34)	Self-timer ( 36)	Macro mode ( 38)	Exposure compensation ( 39)	Touch shooting ( 45, 50)
	 AUTO ¹	Off ²	_ ³	0 ²	 ²
	  ²	Off ²	Off	0 ²	 ²
		Off ²	Off	0 ²	 ²
		Off	Off	0 ²	 ²
	  ⁴	Off ²	Off	0 ²	 ²
	  ^{2, 5}	Off ²	Off	0 ²	 ²
	 AUTO ²	Off ²	Off	0 ²	 ²
	 AUTO ²	Off ²	Off	0 ²	 ²
	 ²	Off ²	Off	0 ²	 ²
		Off ²	Off	0 ²	 ²
		Off ²	Off	0 ²	 ²
	 AUTO ²	Off ²	On	0 ²	 ²
		Off ²	On	0 ²	 ²
		Off ²	Off ²	0 ²	 ²
		Off	Off	0	 ²
	 ²	Off ²	Off ²	0 ²	 ²
	–	–	–	–	–
		Off ²	Off	0 ²	 ²
	 ²	Off ²	Off ²	0 ²	 ²
		– ⁶	Off ²	0 ²	 ⁷

¹ The camera automatically selects the optimum flash mode for the scene mode it has selected ( 62).  (off) can be selected manually.

² The default setting can be changed by tapping the tabs to display the setting controls.

³ When the camera selects close-up scene mode in scene auto selector scene mode, macro mode ( 62) is enabled.



⁴ The flash mode setting is fixed at fill flash with slow sync with red-eye reduction.

⁵ The setting may change to slow sync with red-eye reduction.

⁶ Self-time is disabled ( 70). Pet portrait auto release shutter can be enabled or disabled.

⁷ Touch shutter (default setting) or touch AF/AE can be selected when **Pet portrait auto release** ( 70) is set to **Off**.

Image Mode (Image Quality/Image Size) Setting

The setting specified in other shooting modes also applies in scene mode. This setting can also be changed in scene mode by tapping the bottom tab to display the setting controls and tapping  ( 43).

Adjusting Scene Effect

The scene effect adjustment slider is displayed in the scene modes listed below. Tap or drag the scene effect adjustment slider to adjust the degree of effect to be applied to pictures taken in the selected scene mode.

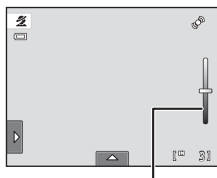







Scene effect adjustment slider

More on Shooting

<p> Portrait, Night portrait, Beach, Snow, Night landscape, Backlighting </p>	<p> ↑ Brighter ↓ Darker </p>
<p> Food </p>	<p> ↑ More red ↓ More blue </p>
<p> Landscape, Close-up </p>	<p> ↑ More vivid ↓ Less vivid </p>
<p> Sunset, Dusk/dawn </p>	<p> ↑ More red ↓ More blue </p>

Shooting in the Scene Mode Selected by the Camera (Scene Auto Selector)

The camera simplifies shooting by automatically selecting the optimum scene mode from the list below when the shot is framed.

- : Auto (general shooting)
- : Landscape
- : Night landscape
- : Backlighting
- : Portrait
- : Night portrait
- : Close-up

1 Press the button in shooting mode and tap .

The scene mode selection screen is displayed.

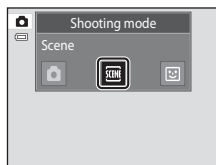

2 Tap Scene auto selector.

The camera enters scene auto selector scene mode.



3 Frame the subject and take a picture.

The shooting mode icon changes to that of the scene mode currently enabled.

Press the shutter-release button halfway to set focus and exposure. When the subject is in focus, the active focus area glows green.



Press the shutter-release button the rest of the way down to take the picture.



Notes on Scene Auto Selector Scene Mode





- Digital zoom is not available.
- Depending upon shooting conditions, the camera may not select the desired scene mode. Should this occur, switch to  (auto) mode (📖 26) or select the desired scene mode manually (📖 58).

Focusing in Scene Auto Selector Scene Mode

- When the camera detects a human face in scene auto selector scene mode, it focuses on that face. See “Face Detection” (📖 41) for more information.
- When the shooting mode indicator  or  (close-up) is displayed, the camera automatically selects one (or more) of the nine focus areas containing the subject closest to the camera.

Functions Available in Scene Auto Selector Scene Mode

When the left or bottom tab is tapped to display the setting controls, the flash mode (📖 34), self-timer (📖 36), exposure compensation (📖 39), image mode (📖 43), and touch shooting (📖 45, 50) settings can be changed.

-  (auto; default setting) or  (off) flash mode can be applied (📖 34). When  (auto) is applied, the camera automatically selects the optimum flash mode for the scene mode it has selected. When  (off) is applied, the flash does not fire, regardless of shooting conditions.
- Macro mode is disabled. Macro mode is only enabled when the camera selects close-up scene mode.
- Changes made to the image mode setting apply to all shooting modes.

Selecting a Scene Mode to Take Pictures (Features)

See “Shooting in the Scene Mode Selected by the Camera (Scene Auto Selector)” (📖 61) for more information on scene auto selector scene mode.

Portrait

Use this mode for portraits.

- When the camera detects a human face, that face will be framed by a yellow double border (focus area). See “Face Detection” (📖 41) for more information.
- If more than one face is detected, the face nearest to the camera will be framed by a double border (focus area) and the other faces will be framed by a single border. Tap the face framed by a single border to change the focus area to that face (📖 45, 50).
- The camera softens skin tones (in up to three faces) by applying the skin softening function before recording pictures (📖 75).
- If no faces are detected when the shutter-release button is pressed halfway, the camera focuses on the subject at the center of the frame.
- Digital zoom is not available.
- The default setting for flash mode is  **Auto with red-eye reduction.**
- Use the scene effect adjustment slider (📖 60) to adjust picture brightness.



Landscape

Use this mode for vivid landscapes and cityscapes.

- Camera focuses at infinity. The focus area or focus indicator (📖 30) always glows green when the shutter-release button is pressed halfway. Note, however, that objects in the foreground may not always be in focus.
- Flash is disabled.
- AF-assist illuminator (📖 156) does not light up.
- Use the scene effect adjustment slider (📖 60) to adjust picture saturation.



Shooting Suited to Scenes (Scene Mode)

Sports

Use this mode for dynamic action shots that freeze the action in a single shot and record motion in a series of pictures.

- The camera focuses on the subject at the center of the frame. The area focused can be changed by the touch shutter (📖 45) or touch AF/AE (📖 50). The camera continuously adjusts the focus until the shutter-release button is pressed halfway to lock the focus.
- While the shutter-release button is held down, up to three pictures are taken at a rate of about 0.7 frames per second (fps) when image mode is set to  **4320x3240**.
- Focus, exposure, and white balance are fixed at the values determined with the first picture in each series.
- The maximum frame rate with continuous shooting may vary depending upon the current image mode setting, the memory card used, or shooting condition.
- Continuous shooting is disabled and only one picture can be taken at a time when the shutter is released using the **Touch shutter** function (📖 45).
- Flash is disabled.
- AF-assist illuminator (📖 156) does not light up.



Night portrait



Use this mode for portraits taken at sunset or at night. The flash fires to light the portrait subject while preserving background lighting to achieve a natural balance between the main subject and background ambience.

- When the camera detects a human face, that face will be framed by a yellow double border (focus area). See “Face Detection” (📖 41) for more information.
- If more than one face is detected, the face nearest to the camera will be framed by a double border (focus area) and the other faces by a single border. Tap the face framed by a single border to change the focus area to that face (📖 45, 50).
- The camera softens skin tones (in up to three faces) by applying the skin softening function before recording pictures (📖 75).
- If no faces are detected when the shutter-release button is pressed halfway, the camera focuses on the subject at the center of the frame.
- Digital zoom is not available.
- The flash mode setting is fixed at fill flash with slow sync with red-eye reduction.
- Use the scene effect adjustment slider (📖 60) to adjust picture brightness.



Use of a tripod is recommended in scene modes with which  is indicated.

Party/indoor

Captures the effects of candlelight and other indoor background lighting.

- Camera focuses on the subject at the center of the frame. The area focused can be changed by the touch shutter (📖 45) or touch AF/AE (📖 50).
- The default setting for flash mode is  **Auto with red-eye reduction**. The flash mode setting may automatically switch to slow sync with red-eye reduction.
- As pictures are easily affected by camera shake, hold the camera steadily. Use of a tripod is recommended in dark surroundings.



Beach

Captures the brightness of such subjects as beaches or sunlit expanses of water.

- Camera focuses on the subject at the center of the frame. The area focused can be changed by the touch shutter (📖 45) or touch AF/AE (📖 50).
- Use the scene effect adjustment slider (📖 60) to adjust picture brightness.



Snow

Captures the brightness of such subjects as snowfield.

- Camera focuses on the subject at the center of the frame. The area focused can be changed by the touch shutter (📖 45) or touch AF/AE (📖 50).
- Use the scene effect adjustment slider (📖 60) to adjust picture brightness.





Shooting Suited to Scenes (Scene Mode)

Sunset



Preserves the deep hues seen in sunsets and sunrises.



- Camera focuses on the subject at the center of the frame.
- The default setting for flash mode is  **Off**.
- Use the scene effect adjustment slider ( 60) to adjust picture color.



Dusk/dawn



Preserves the colors seen in the weak natural light before sunrise or after sunset.



- Camera focuses at infinity. The focus area or focus indicator ( 30) always glows green when the shutter-release button is pressed halfway. Note, however, that objects in the foreground may not always be in focus.
- Flash is disabled.
- AF-assist illuminator ( 156) does not light up.
- Use the scene effect adjustment slider ( 60) to adjust picture color.



Night landscape









Slow shutter speeds are used to produce stunning night landscapes.

- Camera focuses at infinity. The focus area or focus indicator ( 30) always glows green when the shutter-release button is pressed halfway. Note, however, that objects in the foreground may not always be in focus.
- Flash is disabled.
- AF-assist illuminator ( 156) does not light up.
- Use the scene effect adjustment slider ( 60) to adjust picture brightness.



Close-up







Photograph flowers, insects and other small objects at close range.

- Macro mode ( 38) is enabled and the camera automatically zooms to the closest position at which it can focus.
- The closest possible shooting distance may vary according to the zoom position. The camera can focus at a closer distance when  and the zoom indicator glow green and the zoom indicator is positioned to the left of  (wide-angle position). The camera can focus on subjects as close as 10 cm (4 in.) to the lens when zoomed out to the maximum wide-angle position or when zoomed in one step from the maximum wide-angle zoom position. At the  zoom position, the camera can focus at a distance of 30 cm (1 ft.).
- Note that the flash may be unable to light entire subject at distances of less than 50 cm (1 ft. 8 in.).
- Camera focuses on the subject at the center of the frame. The area focused can be changed by the touch shutter ( 45) or touch AF/AE ( 50).
- The camera focuses continuously until focus is locked by pressing the shutter-release button halfway.
- As pictures are easily affected by camera shake, hold the camera steadily.
- Use the scene effect adjustment slider ( 60) to adjust picture saturation.



Food

Use when taking pictures of food.

- Macro mode ( 38) is enabled and the camera automatically zooms to the closest position at which it can focus.
- The closest possible shooting distance may vary according to the zoom position. The camera can focus at a closer distance when  and the zoom indicator glow green and the zoom indicator is positioned to the left of  (wide-angle position). The camera can focus on subjects as close as 10 cm (4 in.) to the lens when zoomed out to the maximum wide-angle position or when zoomed in one step from the maximum wide-angle zoom position. At the  zoom position, the camera can focus at a distance of 30 cm (1 ft.).
- Flash is disabled.
- Camera focuses on the subject at the center of the frame. The area focused can be changed by the touch shutter ( 45) or touch AF/AE ( 50).
- The camera focuses continuously until focus is locked by pressing the shutter-release button halfway.
- As pictures are easily affected by camera shake, hold the camera steadily.
- Use the scene effect adjustment slider ( 60) to adjust the subject's hue affected by the lighting. This adjustment is stored in the camera's memory even after the camera is turned off.



Shooting Suited to Scenes (Scene Mode)

Museum

Use indoors where flash photography is prohibited (for example, in museums and art galleries) or in other settings in which you do not want to use the flash.

- Camera focuses on subject at the center of the frame. The area focused can be changed by the touch shutter (📖 45) or touch AF/AE (📖 50).
- BSS (best shot selector) can be enabled (📖 54).
- BSS (best shot selector) is disabled with touch shutter shooting (📖 45).
- As pictures are easily affected by camera shake, hold the camera steadily.
- Flash is disabled.
- AF-assist illuminator (📖 156) does not light up.



Fireworks show

Slow shutter speeds are used to capture the expanding burst of light from a firework.

- Camera focuses at infinity. The focus indicator (📖 30) always glows green when the shutter-release button is pressed halfway. Note, however, that objects in the foreground may not always be in focus.
- Flash is disabled.
- AF-assist illuminator (📖 156) does not light up.



Black and white copy

Provides clear pictures of text or drawings on a white board or in print.

- Camera focuses on subject at the center of the frame. The area focused can be changed by the touch shutter (📖 45) or touch AF/AE (📖 50).
- Use macro mode (📖 38) to focus at short ranges.
- Colored text and drawings may not show up well.
- The default setting for flash mode is  **Off**.

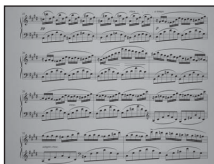

Draw

Write a memo or draw a picture on the touch panel display and save it as an image. See “Using the Draw Option” (📖 71) for more information.

Backlighting

Use when light is coming from behind subject, throwing features or details into shadow. The flash fires automatically to “fill in” (illuminate) shadows.

- Camera focuses on subject at the center of the frame. The area focused can be changed by the touch shutter (📖 45) or touch AF/AE (📖 50).
- The flash mode setting is fixed at  **Fill flash**.
- Use the scene effect adjustment slider (📖 60) to adjust picture brightness.



Panorama assist



Use when taking a series of pictures that will later be joined to form a single panorama using the supplied Panorama Maker 5 software. See “Shooting for a Panorama” (📖 72) for details.







- The default setting for flash mode is  **Off**.

Shooting Suited to Scenes (Scene Mode)

Pet portrait

Use this mode for taking portraits of pets (dogs or cats). When the camera detects the face of a dog or cat, it focuses on the face and automatically releases the shutter (pet portrait auto release) three times at the default setting.



- A double border (focus area) is displayed around the detected face, and it turns green when the focus is acquired. Up to five faces can be detected. When the camera detects more than one face, the double border is displayed around the largest face, and single borders are displayed around the others.
- If the shutter-release button is pressed halfway when no pet faces are detected, the camera focuses on the subject at the center of the frame.
- To change the  **Continuous** setting used in this mode, tap the bottom tab to display the setting controls.
 - **Single**: The camera takes one picture at a time.
 - **Continuous** (default setting): When the pet portrait auto release function is activated and the focus is acquired on the detected face, the camera releases the shutter three times (continuous shooting speed rate: about 0.7 frames per second when the image mode setting is  **4320x3240**). When the pet portrait auto release function is disabled, up to three pictures can be continuously taken at a rate of about 0.7 frames per second while the shutter-release button is held down (when the image mode setting is  **4320x3240**).
- To change the  **Pet portrait auto release** setting, tap the bottom tab to display the setting controls.
 - **On** (default setting): The shutter is automatically released when the focus is acquired on the detected face.
 - **Off**: The shutter is released using the shutter-release button or touch shutter ( 45).
- Digital zoom is not available.
- Flash is disabled.
- AF-assist illuminator ( 156) does not light up. Shutter sound ( 157) is disabled.
- Factors such as the distance between the pet and the camera, the orientation or brightness of the face, and the speed at which the pet is moving may prevent the camera from detecting the faces of dogs or cats or may cause it to detect faces other than those of dogs or cats.

Using the Draw Option

Write a memo, or draw a picture, on the touch panel display and save it as an image. The image is saved at an image mode setting of **VGA 640×480**.

- 1** Press the  button in shooting mode and tap **SCENE**.

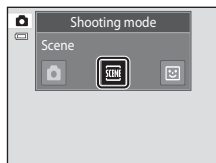

The scene mode selection screen is displayed.



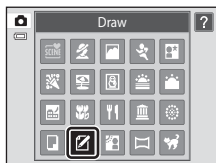





- 2** Tap  **Draw**.



- 3** Write a memo or draw pictures.

Tap  (pen) to write text or draw pictures, and tap  (eraser) to erase text or pictures (113).

Tap  to display the picture in full-frame playback mode and tap  again to enlarge the picture display by 3x. Tap , , or  to change the portion of the picture visible in the monitor. Tap  to return to the original display size.



- 4** Tap **OK**.

Tap  before tapping **OK**, to undo the last operation applied using the pen or erase tool (up to the last five operations can be undone).

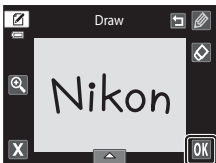

- 5** Tap **Yes**.

The memo is saved.

To cancel saving the memo, tap **No**.

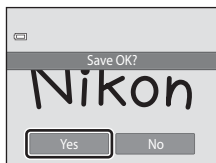

Shooting for a Panorama

The camera focuses on the subject at the center of the frame. Use a tripod for the best results.

- 1 Press the  button in shooting mode and tap .

The scene mode selection screen is displayed.

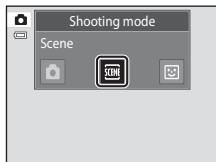
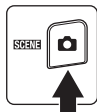

- 2 Tap  **Panorama assist**.

Panorama direction icons are displayed to show the direction in which pictures will be joined.



- 3 Tap a direction icon.

Select the direction in which pictures will be joined in the completed panorama; right () , left () , up () or down () .

A different direction can be selected by tapping a different panorama direction icon.

Change shooting settings ( 59) before the first picture is taken in the next step.



- 4 Take the first picture.

One third of the picture will be displayed as translucent.



5 Take the next picture.

Frame the next picture so that one-third of the frame overlaps the previous picture and press the shutter-release button.

Repeat this process until the necessary number of pictures have been taken to complete the scene.

**6 Tap X when shooting is complete.**

The camera returns to step 3.

**✓ Notes on Panorama Assist**

- Apply or adjust shooting settings (📖 59) before releasing the shutter for the first picture. Shooting settings cannot be changed after the first picture is taken. Pictures cannot be deleted, nor can zoom operate after the first picture has been taken.
- Shooting for the panorama series is terminated if the auto off function (📖 158) initiates standby mode during shooting. Setting the time allowed to elapse before the auto off function is enabled to a longer setting is recommended.

🔍 AE/AF-L Indicator

In **Panorama assist** scene mode, exposure, white balance, and focus for all pictures in a panorama are fixed at the values for the first picture in each series.

When the first picture is taken, **AE/AF-L** is displayed to indicate that exposure, white balance, and focus are locked.

**🔍 Panorama Maker 5**

Install Panorama Maker 5 from the supplied ViewNX 2 CD. Transfer pictures to a computer (📖 134) and use Panorama Maker 5 (📖 138) to join them in a single panorama.

🔍 More Information

See "Image/Sound File and Folder Names" (📖 174) for more information.

Shooting Smiling Faces (Smart Portrait Mode)

At the default settings, the camera uses the face detection function to detect human faces, and then automatically releases the shutter when a smile is detected (smile timer). The skin softening option can be used to smooth skin tones of human faces.

1 Press the button in shooting mode and tap .

The camera enters smart portrait mode.

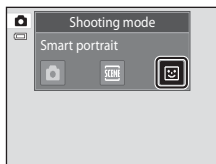

2 Frame a picture.

Point the camera at the subject.

When the camera detects a human face, a yellow double border (focus area) is displayed around that face. When focus is acquired on that face, the double border will turn green for a moment and focus is locked.

Up to three faces can be detected. When the camera detects more than one face, the double border is displayed around the face closest to the center of the frame, and single borders around the others. Tap the face framed by a single border to change the focus area to that face.



3 The shutter is automatically released.

If the camera detects that the face framed by the double border is smiling, **Smile timer** (📖 77) is activated and the shutter is automatically released.

Each time the shutter is released, the camera again initiates face detection and smile detection operations for continuous automatic shooting.

4 Shooting ends.

To stop automatic shooting of smiling faces, either turn the camera off, set **Smile timer** to **off**, or press the  button and select another shooting mode.

 **Notes on Smart Portrait Mode**

- Digital zoom is not available.
- Under some shooting conditions, the camera may be unable to detect faces or smiles.
- See "Notes on the Face Detection Function" (📖 41) for more information.

 **Notes on Skin Softening Function**

- More time than usual may be required to save a picture when shooting with skin softening function.
- In some shooting conditions, facial skin tones may not be smoothed or parts other than face may be modified though the camera detects a face. If the desired results are not produced, set **Skin softening** to **Off** and shoot again.
- The skin softening level cannot be adjusted when **Portrait** or **Night portrait** is selected in the scene mode.
- Retouch effects such as the glamour retouch function's skin softening effect can be applied to pictures after they are taken (📖 121).

 **Self-timer Lamp**

The self-timer lamp blinks slowly when the smile timer is enabled and the camera detects a face, and it blinks quickly immediately after the shutter is released.

 **Releasing the Shutter Manually**

Pictures can also be taken by pressing the shutter-release button. The camera focuses on the subject at the center of the frame when faces are not detected.

 **Auto Off in Smile Timer Mode**

When **Smile timer** is set to **On**, the auto off function (📖 158) is activated and the camera turns off when either of the situations indicated below persists and no other operations are performed.

- The camera does not detect any faces.
- The camera detected a face, but cannot detect a smile.

 **More Information**

See "Autofocus" (📖 31) for more information.

Changing the Smart Portrait Mode Settings

The settings indicated below can be made by tapping the tabs to display the setting controls in smart portrait mode.

- Each icon also indicates the current setting.
- Tap the icon of the desired item to display the setting screen for that item.
- Tap the tab again to hide the setting controls.

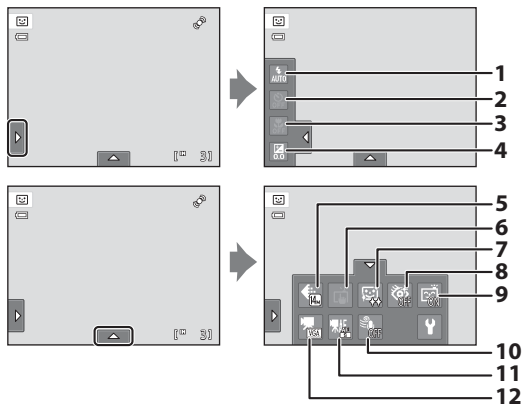

1 Flash mode

Set the flash mode (📖 34) when taking pictures in smart portrait mode.

2 Self-timer

Set the self-timer (📖 36). The self-timer is not available when **Smile timer** is set to **On** (📖 77).

3 Macro mode

Macro mode is disabled (📖 38).

4 Exposure compensation

Adjust **Exposure compensation** (📖 39) with shooting in smart portrait mode.

5 Image mode

Choose the image mode (combination of image size and compression rate) at which images are saved (📖 43).

Changes made to the image mode setting apply to all shooting modes.

6  Touch shutter

Switch between the touch shutter ( 45) and touch AF/AE ( 50). Both are disabled when **Smile timer** is set to **On** ( 77).

7  Skin softening

Enable skin softening. When the shutter is released, the camera detects one or more human faces (up to three), and processes the image to soften facial skin tones before saving the picture.

The degree of skin softening applied can be selected from **High**, **Normal** (default setting), and **Low**. When **Off** is selected, the skin softening function is disabled.

- The effects of skin softening are not visible when framing pictures for shooting. Check the degree of skin softening performed in playback mode.

8  Blink proof

When **On** is selected, the camera automatically releases the shutter twice each time a picture is taken. Of the two shots, one in which the subject's eyes are open is saved.

- If the camera saved a picture in which the subject's eyes may have been closed, the dialog shown at right is displayed for a few seconds.
- When **On** is selected, the flash is disabled.
- The default setting is **Off**.

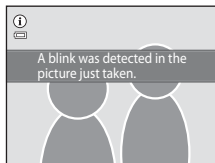
9  Smile timer

- **On** (default setting): The camera uses the face detection function to detect a human face, and then automatically releases the shutter whenever a smile is detected.
- **Off**: The camera does not release the shutter automatically with smile detection. Press the shutter-release button to take a picture.

10  Wind noise reduction

Set whether or not to reduce wind noise during movie recording ( 126, 130).

11  Movie AF mode

Select the autofocus mode during movie recording ( 126, 129).

12  Movie options

Select the desired movie option when recording movies ( 126, 128).



 **Settings in Smart Portrait Mode**

There are functions with which this setting cannot be enabled. See “Camera Settings that Cannot Be Applied Simultaneously” ( 78) for more information.

Camera Settings that Cannot Be Applied Simultaneously





Some shooting settings cannot be used with other functions.

Restricted function	Setting	Description
Flash mode	Continuous (📖 54)	When Continuous , BSS , or Multi-shot 16 is selected, flash is disabled.
	Blink proof (📖 77)	When On is selected, flash is disabled.
Self-timer	Subject tracking (📖 48)	When the touch shooting is set to Subject tracking , self-timer is disabled.
Macro mode	Subject tracking (📖 48)	When the touch shooting is set to Subject tracking , macro mode is disabled.
Image mode	Continuous (📖 54)	When Multi-shot 16 is selected, the Image mode setting is fixed at 5 (image size: 2560 × 1920 pixels).
ISO sensitivity	Continuous (📖 54)	When Multi-shot 16 is selected, the ISO sensitivity setting is automatically specified according to the brightness.
Continuous	Self-timer (📖 36)	When taking a picture using the self-timer, the continuous setting is fixed to Single .
	Touch shutter (📖 45)	When using the touch shutter function, one picture is taken each time the monitor is tapped.
Electronic VR	Continuous (📖 54)	When Continuous , BSS , or Multi-shot 16 is selected, electronic VR is disabled.
	ISO sensitivity (📖 53)	When a setting other than Auto is selected for ISO sensitivity , electronic VR is disabled.
	Blink proof (📖 77)	When On is selected, electronic VR is disabled.
Motion detection	Subject tracking (📖 48)	When taking a picture using the subject tracking function, Motion detection is disabled.
	Continuous (📖 54)	When Multi-shot 16 is selected, Motion detection is not enabled.
	ISO sensitivity (📖 53)	When a setting other than Auto is selected for ISO sensitivity , Motion detection is disabled.
Blink warning	Continuous (📖 54)	When Continuous , BSS , or Multi-shot 16 is selected, Blink warning is disabled.

Restricted function	Setting	Description
Digital zoom	Continuous  54	When Multi-shot 16 is selected, digital zoom is not available.
	Subject tracking  48	When the touch shooting is set to Subject tracking , digital zoom is disabled.

Restricted Functions in Shooting Mode



The restricted functions vary with the shooting mode ( 40). See the following pages for details on the functions available in each shooting mode:

-  (auto) mode →  42
- Scene mode →  59
- Smart portrait mode →  76

More Information















See “Notes on Digital Zoom” ( 156) for more information.

Operations in Full-frame Playback Mode

Press the  (playback) button to enter playback mode and display pictures that have been taken ( 32).



The following operations are available in full-frame playback mode.

To	Use	Description	
Select a picture	–	Drag the picture to the right to display the previous picture and to the left to display the next picture.	32
View thumbnails	W 	Rotate the zoom control to W  to display 4, 9 or 16 picture thumbnails.	81
Playback zoom	T 	Rotate the zoom control to T  to enlarge the picture up to 10x. Tap X to return to full-frame playback mode.	83
Playback movies		Tap  to play back the movie currently displayed.	131
Set the picture rating/play back pictures by rating	Right tab (★)	Apply a rating of one to five to each picture or play back pictures by rating.	99
Make playback settings	Bottom tab	Tap the bottom tab to specify the playback settings and edit pictures.	98
Switch to another playback mode		Press the  button to display the playback-mode selection menu and change to favorite pictures, auto sort, or list by date mode.	85
Switch to shooting mode	  	Press the  button,  (movie-record) button, or shutter-release button.	32

Changing the Orientation (Vertical/Horizontal) of Pictures

Picture orientation can be changed using **Rotate image** ( 107) after pictures are taken.

Viewing Multiple Pictures: Thumbnail Playback

Rotate the zoom control to **W** (📐) in full-frame playback mode (📖 80) to display pictures in “contact sheets” of thumbnail images.



The following operations are available while thumbnails are displayed.

To	Use	Description	
Increase the number of pictures displayed	W (📐)	Rotate the zoom control to W (📐) to increase the number of the picture thumbnails displayed: 4 → 9 → 16.	
Decrease the number of pictures displayed	T (📏)	Rotate the zoom control to T (📏) to decrease the number of picture thumbnails displayed: 16 → 9 → 4. Rotate the zoom control to T (📏) in 4-picture thumbnail display to return to full-frame playback mode.	–
Scroll display	▲ or ▼	Tap ▲ or ▼ . It is also possible to scroll through the thumbnails by dragging your finger up or down across the monitor.	–
Switch to full-frame playback mode	–	Tap a picture.	32
Set the picture rating/play back pictures by rating	Right tab (★)	Apply a rating of one to five to each picture or play back pictures by rating.	99
Make playback settings	Bottom tab	Tap the bottom tab, and Delete , Slide show , Protect , or Print order settings can be enabled.	98
Switch to shooting mode	● 	Press the button, ● (🎬 movie-record) button, or shutter-release button.	32

Viewing Multiple Pictures: Thumbnail Playback

Thumbnail Playback Mode Display

Pictures with ratings (📖 99) and protected pictures (🔒 101) are displayed with the icons shown at right. Movies are displayed as film frames.

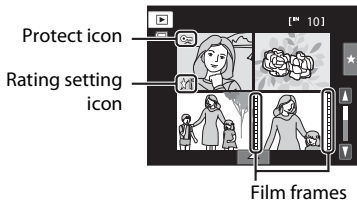

Thumbnail Display in Favorite Pictures and Auto Sort Mode

- When thumbnails are displayed in favorite pictures mode (📖 86), the favorite pictures icon is displayed in the monitor.



- When thumbnails are displayed in auto sort mode (📖 93), the pictures' category icon is displayed in the monitor.





Taking a Closer Look: Playback Zoom

Rotating the zoom control to **T** (🔍) in full-frame playback mode (📖 80) enlarges display of the center portion of the current picture.

- The guide displayed at bottom right shows the portion of the image currently displayed.

The following operations can be performed while picture display is enlarged.



To	Use	Description	📖
Zoom in	T (🔍)	Zoom increases each time the zoom control is rotated to T (🔍), to a maximum of 10x.	–
Zoom out	W (📐)	Zoom decreases each time the zoom control is rotated to W (📐). When the magnification ratio reaches 1x, the display returns to full-frame playback mode.	–
Change the display area	–	The area of the picture currently displayed can be changed by dragging the picture.	–
Delete pictures	🗑️	Tap 🗑️ to delete the picture.	33
Switch to full-frame playback	✕	Tap ✕ to switch to full-frame playback.	32
Crop picture	✂️	Tap ✂️ to crop current picture to contain only the portion visible in the monitor.	124
Switch to shooting mode	  	Press the 📷 button, ● (🎬 movie-record) button, or shutter-release button.	32

Pictures Taken with Face Detection or Pet Detection

When rotating the zoom control to **T** (👤) to zoom in (playback zoom) on a picture taken using the face detection (📖 41) or pet detection (📖 70) function, the picture is enlarged with the detected face at the center of the monitor except pictures taken using **Continuous**, **BSS**, and **Multi-shot 16**, or the subject tracking function.



- If more than one face was detected, the picture will be enlarged with the face on which focus was acquired at the center of the monitor. Tap 📷 or 📷 to display other detected faces.
- When the zoom control is rotated to **T** (👤) or **W** (📐) to adjust the zoom ratio, the center of the picture, rather than the face, is displayed at the center of the monitor (normal playback zoom display).

Selecting Playback Mode



Following playback modes can be selected.

 **Playback mode**  32

Play back all pictures.

 **Favorite pictures mode**  86

Play back pictures added to an album.

 **Auto sort mode**  93

Play back pictures and movies automatically sorted to the selected category with shooting.

 **List by date mode**  96

Play back pictures taken on the selected date.

1 Press the  button in playback mode.

The playback mode selection menu is displayed.

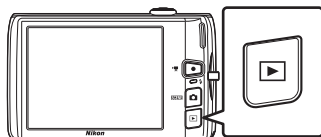

2 Tap the desired playback mode icon.

The camera enters the selected playback mode.

To return to the current playback mode, press the  button.

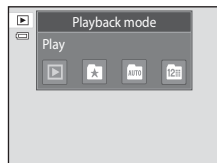

More on Playback

Sorting Favorite Pictures (Favorite Pictures Mode)

Pictures can be sorted to albums. Once pictures have been sorted to albums, favorite pictures mode can be used to play back only the pictures in a specific album.

- Adding pictures to albums makes finding a particular picture faster and easier.
- Pictures can be sorted to albums categorized by themes such as travel or weddings.
- A single picture can be added to multiple albums.

Adding Pictures to Albums

Pictures can be added to albums and sorted.

1 Display pictures in playback mode (📖 32), auto sort mode (📖 93), or list by date mode (📖 96).

2 Select a picture and tap the bottom tab.

Display a picture in full-frame playback mode and tap the bottom tab.

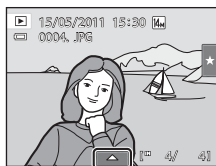

3 Tap .

The albums selection screen is displayed.



4 Tap the desired album.

The picture is added to the album and monitor display returns to full-frame playback mode.

To add the same picture to other albums, repeat the procedure from step 1 or 2.

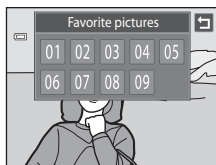

Notes on Adding Favorite Pictures

- An album can contain up to 200 pictures.
- Movies cannot be added to albums.
- If the selected picture has already been added to an album, the album icon turns yellow.
- When pictures are added to albums, they are not physically copied to albums or moved from the folder (📁 174) to which they were originally recorded (📁 92).

More Information

See "Removing Pictures from Albums" (📁 89) for more information.

Viewing Pictures in an Album

Pictures can be displayed by selecting the album to which they were added in “ favorite pictures mode”.

- In full-frame playback mode, just as with normal playback mode, picture display can be enlarged, or pictures can be displayed as thumbnails. When the bottom tab is tapped to display the setting controls, settings can be made and editing can be performed on pictures sorted to the specified album ( 98).

- 1** Press the  button in playback mode and tap .

A list of albums is displayed.

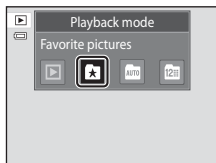
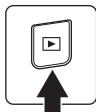

- 2** Tap the desired album.

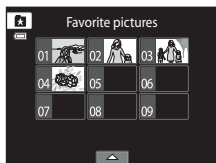

The pictures in the selected album will be displayed in full-frame playback mode.

The icon for the current album is displayed on the screen.

Repeat steps 1 and 2 to select a different album.



Removing Pictures from Albums

To remove a picture from an album without permanently deleting it, follow the procedures described below.

- Select the desired picture in full-frame display in step 2 in favorite pictures mode (📖 88), tap the bottom tab to display the setting controls, and then tap . The confirmation dialog is displayed.
- Tap **Yes** to remove the picture from the album. To exit without removing the picture, tap **No**.

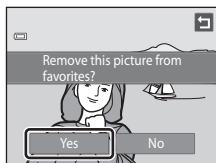













Note on Deleting Pictures in Favorite Pictures Mode

Note that deleting a picture in favorite pictures mode deletes not only the picture from the album, but also deletes the original picture from the internal memory or memory card permanently (📖 92).

Operations in Favorite Pictures Mode

The following operations are available in the album list screen shown in step 2 on page 88.

To	Use	Description	
Change the album icon		Tap the bottom tab to display the setting controls, and tap  .	91
Delete all pictures in the selected album		When the bottom tab is tapped to display the setting controls, and  is tapped, the album selection screen is displayed. Select the desired album and tap OK .	–
Change playback mode		Press the  button to display the playback-mode selection menu.	85
Switch to shooting mode	  	Press the  button,  (movie-record) button, or shutter-release button.	32

Changing Icons Assigned to Albums

The icon assigned to an album can be changed to reflect the theme of pictures included in the album.

- 1 Press the  button in playback mode and tap .

A list of albums is displayed.

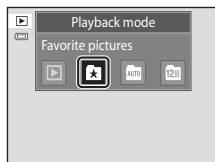

- 2 Tap the bottom tab to display the setting controls and tap .

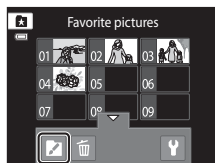

- 3 Tap the desired folder.

The album icon and icon color selection screen is displayed.

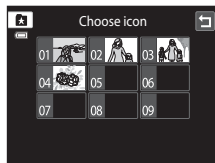

- 4 Tap the desired icon to be assigned to an album, tap or drag the slider to select the icon's color, and tap **OK**.

The icon is modified and the monitor display returns to the list of albums.

Tap  to return to the album selection screen without changing settings.

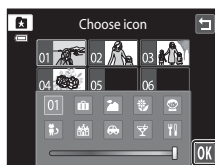

Notes on Icons for Albums

Choose icons for albums separately for the internal memory and for every memory card used.

- To change the icon for an album containing pictures stored in the internal memory, remove the memory card from the camera.
- The default setting for icons are numbers.

Sorting Favorite Pictures (Favorite Pictures Mode)

Adding/Viewing Favorite Pictures

When pictures are added to albums, they are not physically copied to albums or moved from the folder to which they were originally recorded (📖 174). Only the file names of pictures are added to albums. In favorite pictures mode, pictures with file names that have been added to the specified album are played back. Note that deleting a picture (📖 33, 90) played back in favorite pictures mode deletes not only the picture from the album, but also deletes the original picture from the internal memory or memory card permanently.

Adding Pictures to Albums

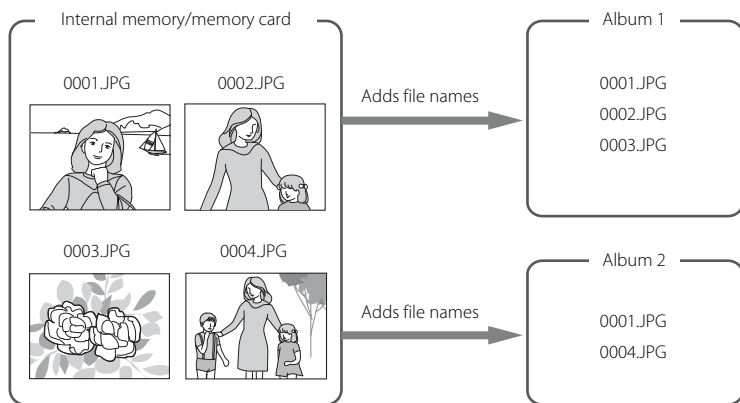

More on Playback

Favorites Picture Playback

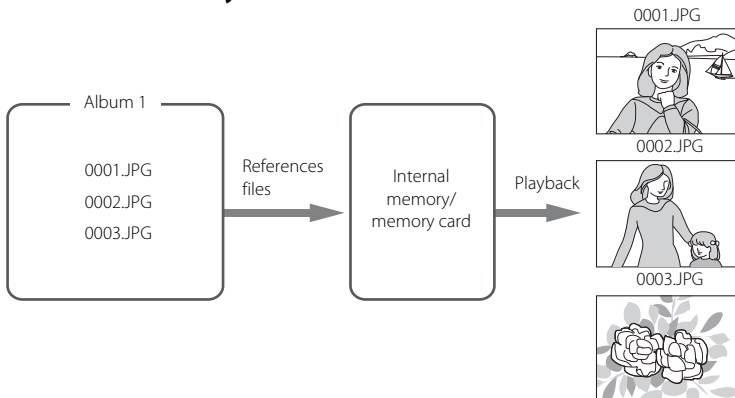

Image Searching in Auto Sort Mode

When shooting pictures and movies, they are automatically sorted to one of the categories shown below. When “**AUTO** (auto sort) mode” is selected, pictures and movies can be viewed by selecting the category to which they were sorted.

Smile	Portraits	Food
Landscape	Dusk to dawn	Close-ups
Pet portrait	Movie	Retouched copies
Other scenes		

- In full-frame playback mode, just as with normal playback mode, picture display can be enlarged, pictures can be displayed as thumbnails, and movies can be played back. When the bottom tab is tapped to display the setting controls, settings can be made and editing can be performed on pictures sorted to the specified category (📖 98).

Viewing Pictures in Auto Sort Mode

- 1 Press the button in playback mode and tap **AUTO**.

A list of categories is displayed.

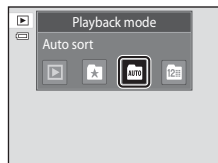

- 2 Tap the desired category.

For more information on categories, see “Auto Sort Mode Categories” (📖 94).













A picture sorted to the selected category will be displayed in full-frame playback mode.

The icon for the category currently selected is displayed.

Repeat steps 1 and 2 to select a different category.



Auto Sort Mode Categories

Category	Description
 Smile	Pictures taken in smart portrait mode (📖 74) with the smile timer setting set to On .
 Portraits	Pictures taken in  (auto) mode (📖 26) with the face detection function (📖 41). Pictures taken in Portrait* , Night portrait* , Party/indoor , and Backlighting* scene modes (📖 58). Pictures taken in smart portrait mode (📖 74) with the smile timer setting set to Off .
 Food	Pictures taken in Food scene mode (📖 58).
 Landscape	Pictures taken in Landscape* scene mode (📖 58).
 Dusk to dawn	Pictures taken in Night landscape* , Sunset , Dusk/dawn , and Fireworks show scene modes (📖 58).
 Close-ups	Pictures taken in  (auto) mode with the macro mode setting (📖 38). Pictures taken in Close-up* scene mode (📖 58).
 Pet portrait	Pictures taken in Pet portrait scene mode (📖 58).
 Movie	Movies (📖 126).
 Retouched copies	Copies created using editing functions (📖 110).
 Other scenes	All other pictures that cannot be defined by the categories described above.











* Pictures taken in scene auto selector scene mode (📖 61) are also sorted to the appropriate categories.

Notes on Auto Sort Mode

- Up to 999 pictures and movie files can be sorted to each category in auto sort mode. If 999 pictures or movies have already been sorted to a specific category, new pictures and movies cannot be sorted to that category or displayed in auto sort mode. Display pictures and movies that could not be sorted to a category in normal playback mode (📖 32) or list by date mode (📖 96).
- Pictures or movies copied from the internal memory to a memory card, or vice versa (📖 167), cannot be displayed in auto sort mode.
- Pictures or movies recorded by a camera other than the COOLPIX S4100 cannot be displayed in auto sort mode.

Operations in Auto Sort Mode

The following operations are available on the auto sort mode category list screen shown in step 2 on page 93.

To	Use	Description	
Delete all pictures in the selected category		When the bottom tab is tapped to display the setting controls, and  is tapped, the category selection screen is displayed. Select the desired category and tap OK .	-
Switch to another playback mode		Press the  button to display the playback-mode selection menu.	85
Switch to shooting mode	  	Press the  button,  ( movie-record) button, or shutter-release button.	32

Selecting Pictures Taken on a Specific Day (List by Date Mode)

In “ list by date mode”, pictures taken on a same date can be played back.

- In full-frame playback mode, just as with normal playback mode, picture display can be enlarged, pictures can be displayed as thumbnails, and movies can be played back. When the bottom tab is tapped to display the setting controls, settings can be made and editing can be performed on pictures taken on a specific day ( 98).

Selecting a Date in List by Date Mode

- 1 Press the  button in playback mode and tap .

Dates for which pictures exist are listed.

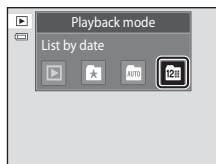

- 2 Tap the desired date.

To change the displayed month, tap  or .



The first picture taken on the selected date will be displayed full-frame.

Repeat steps 1 and 2 to select a different date.

















Notes on List by Date Mode

- Up to 9,000 of the most recently recorded pictures can be displayed in list by date mode.
- Pictures taken before the date and time have been set are recognized as having been taken on January 1, 2011.

Operations in List by Date Mode

The following operations are available in the list by date screen shown in step 2 on page 96.

To	Use	Description	
Change the month	 or 	Tap  or  .	–
Delete all pictures in the selected date		When the bottom tab is tapped to display the setting controls, and  is tapped, the date selection screen is displayed. Select the desired date and tap  .	–
Switch to another playback mode		Press the  button to display the playback-mode selection menu.	85
Switch to shooting mode	  	Press the  button,  (movie-record) button, or shutter-release button.	32

Playback Options

To adjust picture settings or edit pictures, tap the tab in full-frame playback mode to display the setting controls.

- The controls available and monitor display vary depending upon the current picture and camera settings.
- Tap the icon of the desired item to display the setting screen for that item.
- Tap the tab again to hide the setting controls.

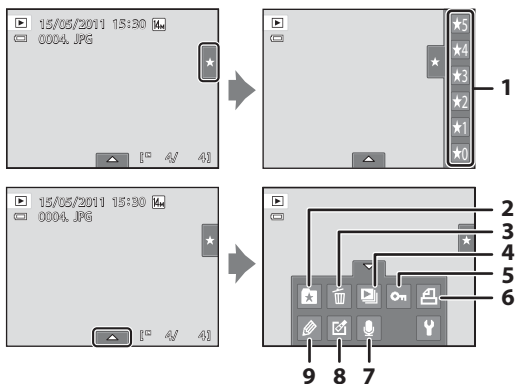

1	Rating*	99	5	Protect*	101
2	★ Add pictures to albums (except in favorite pictures mode)	86	6	DPOF print order*	103
	Remove pictures from albums (in favorite pictures mode)	89	7	Voice memo	108
3	🗑 Delete*	33	8	Retouch	110
4	📺 Slide show*	100	9	Rotate image	107
				Paint	112

* This function can also be performed in thumbnail playback mode. If the camera is switched to thumbnail playback mode while pictures are played back in favorite pictures, auto sort, or list by date mode, this function can be performed only on the pictures sorted to the selected folder, category or date.

Setting the Picture Rating

A rating of one to five can be assigned to each picture. It is also possible to play back only the pictures that have been assigned a specific rating.

- 1 Tap the right tab in full-frame playback (📖 80) or thumbnail playback (📖 81) mode.

See "Operating the Tabs" (📖 14) for more information.



- 2 Drag and drop (📖 8) the desired rating icon onto the picture.

Rating is applied.

Drag and drop another icon to change the rating.

Drag and drop ★0 to cancel the rating.

A picture's rating can be confirmed by the number of ☆ shown in full-frame playback mode.

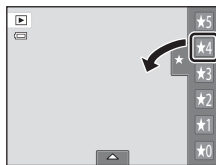

Playing Back Pictures by Rating

- 1 Tap the right tab in full-frame playback (📖 80) or thumbnail playback (📖 81) mode.



- 2 Tap a rating icon to display the pictures with that rating.

The icon of the tapped rating turns yellow, and only the pictures assigned with the selected rating are displayed. Multiple ratings can be selected.

To stop displaying pictures of a selected rating, tap the icon of the rating to deselect it.

To stop playback by rating, deselect all ratings.



✓ Notes on the Rating

- Each rating can be applied to a maximum of 999 pictures.
- Rating cannot be applied to movies.
- The ratings applied on the COOLPIX S4100 are not recognized by your computer.

Enjoying Slide Show

Play back pictures stored in the internal memory or on a memory card one by one in an automated “slide show.”

- 1 Tap the bottom tab in playback mode to display the setting controls, and tap .

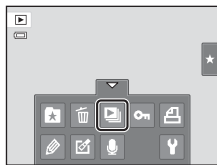

- 2 Tap **Start**.

To change the effect, tap **Effects** before selecting **Start**, and select from **Classic**, **Zoom**, or **Animated**.

To change the interval between pictures, tap **Frame intvl** and select the desired interval before tapping **Start**.

To repeat the slide show automatically, tap **Loop** before tapping **Start**. A check mark (✓) will be added to the loop option when enabled.

To exit without playing back pictures in a slide show, tap .

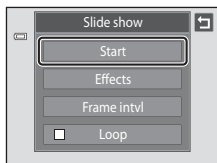







- 3 The slide show begins.

Tap the monitor to display the operation panel at the bottom of the screen.

Tap the icons in the operation panel to perform the corresponding operation. The following operations are available.



To	Tap	Description
Rewind		Tap and hold  to rewind slide show.
Advance		Tap and hold  to advance slide show.
Pause		Pause playback. <ul style="list-style-type: none">• To resume playback, tap  displayed at the center of the screen.
End		End slide show.

Notes on Slide Show

- Only the first frame of movies included in slide shows is displayed.
- Even when **Loop** is selected, the slide show will only be played for a maximum of 30 minutes (158).

Protecting Important Pictures (Protect)

Protect selected pictures from accidental deletion. Protected pictures are recognized by the  icon ([12](#)) in playback mode.

Protecting One Picture

- 1 Select the desired picture to be protected in full-frame playback mode and tap the bottom tab.



- 2 Tap .



- 3 Tap **On**.

The selected picture is protected.

To exit without protecting pictures, tap .



Note on Protecting Pictures

Note that formatting the camera's internal memory or the memory card will permanently delete protected files ([159](#)).

Protecting Multiple Pictures

Multiple pictures can be protected at a time.

- 1 Switch to thumbnail playback mode (81), tap the bottom tab to display the setting controls, and tap **Protect**.

The monitor display switches to the **Protect** screen.

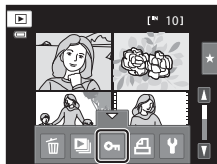

- 2 Tap the desired pictures to be protected.

When a picture is selected, a check mark is displayed. To cancel the selection, tap the picture again.

Tap **Ⓜ** or **Ⓛ**, or rotate the zoom control to **T** (Ⓚ) or **W** (Ⓜ) to change the number of pictures displayed.



- 3 Tap **OK**.

The selected pictures are protected.

To exit without protecting pictures, tap **⏪**.



Removing Protection from Pictures

- To remove protection from a picture, display a protected picture in full-frame playback mode, follow the procedure in "Protecting One Picture" (81), and tap **Off** in step 3.
- To remove protection from multiple pictures at a time, uncheck protected pictures in step 2 of "Protecting Multiple Pictures".

Creating a DPOF Print Order

When printing pictures stored on the memory card using any of the following methods, the **Print order** option in the playback menu is used to create digital “print orders” for printing on DPOF-compatible devices.

- Inserting the memory card into a DPOF-compatible ( 190) printer’s card slot
- Taking the memory card to a digital photo lab
- Connecting the camera to a PictBridge-compatible ( 190) printer ( 140). A print order can also be created for pictures stored in the internal memory if the memory card is removed from the camera

Creating a Print Order for One Picture

- 1** Select the desired picture in full-frame playback mode and tap the bottom tab.

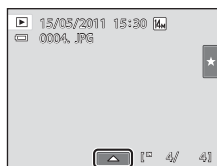

- 2** Tap .



- 3** Tap the desired number of copies (up to nine) and tap .

To exit without making the print order setting, tap .

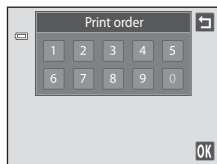

If the total number of pictures in a print order, including pictures just added, exceeds 99, the screen shown at right will be displayed.

- Tap **Yes** to remove pictures previously added from the print order and restrict the print order to pictures just marked.
- Tap **Cancel** to remove the pictures just added from the print order and restrict the print order to pictures previously marked.

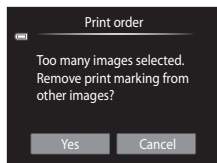



4 Choose whether or not to print shooting date and photo information.

Tap **Date** to place in the checkbox to imprint the shooting date on the picture.

Tap **Info** to place in the checkbox to imprint the photo information (shutter speed and aperture value) on the picture.

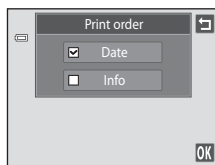
Tap **OK** to complete the print order.



Pictures selected for printing are recognized by the  icon displayed with playback.

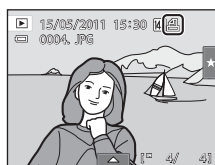

Creating a Print Order for Multiple Pictures

- 1 Switch to thumbnail playback mode (📖 81), tap the bottom tab to display the setting controls, and tap 🖨️.

The monitor display switches to the print order setting screen.



- 2 Tap the desired pictures to print (up to 99) and tap 📄 or 📄 at the upper left in the monitor to specify the number of copies (up to nine) for each.

Pictures selected for printing can be recognized by the check mark (✔️) and the numeral indicating the number of copies to be printed. If no copies have been specified for pictures, the selection is canceled.

Tap 🔍 or 🔍, or rotate the zoom control to **T** or **W** to change the number of pictures displayed.

Tap 🔄 to remove print markings from all pictures and cancel the print order.

Tap OK when setting is complete.



- 3 Choose whether or not to print shooting date and photo information.

Tap **Date** to place ✔️ in the checkbox to imprint the shooting date on all pictures in the print order.

Tap **Info** to place ✔️ in the checkbox to imprint the photo information (shutter speed and aperture value) on all pictures in the print order.

Tap OK to complete the print order.

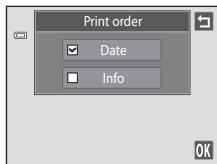

Canceling Print Order

- To remove a print marking from a picture, display a picture selected for printing in full-frame playback mode, follow the procedure in “Creating a Print Order for One Picture” (📖 103), and tap “0” in step 3.
- To remove print markings from multiple pictures at a time, remove the print markings of the desired pictures in step 2 of “Creating a Print Order for Multiple Pictures” (📖 105). Tap  to remove print markings from all pictures.

✔ Notes on Printing Shooting Date and Photo Information

When the **Date** and **Info** options are enabled in the print order option, shooting date and photo information are printed on pictures when a DPOF-compatible printer (📖 190) that supports printing of shooting date and photo information is used.

- Photo information cannot be printed when the camera is connected directly to a printer, via the supplied USB cable, for DPOF printing (📖 145).
- Note that **Date** and **Info** settings are reset each time the **Print order** option is displayed.
- The date printed is that recorded when the picture was taken. Changing the **Date and time** and **Time zone** settings using the **Time zone and date** option in the setup menu after a picture has been taken has no effect on the date printed on the picture.





🕒 Print Date

When date and time of recording are imprinted on pictures using the **Print date** option (📖 153) in the setup menu, pictures are recorded with shooting date and time imprinted on the picture when they are taken. Pictures with the date imprinted on them can be printed from printers that do not support printing of the date on pictures.

Only the date and time imprinted on pictures using the **Print date** option will be printed, even if the date print option is enabled in the **Print order** menu.

Rotate Image

Specify the orientation in which recorded pictures are displayed with playback. Still pictures can be rotated 90 degrees clockwise or 90 degrees counterclockwise. Pictures that were recorded in portrait (“tall”) orientation can be rotated up to 180 degrees in either direction.

- 1 Select a picture in the full-frame playback mode ( 80), tap the bottom tab to display the setting controls, and tap .

The retouch menu is displayed.



- 2 Tap .

The rotate image screen is displayed.

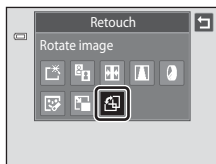

- 3 Tap  or .

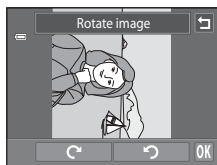

Rotate 90 degrees clockwise

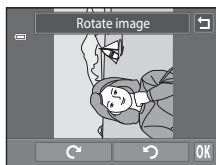
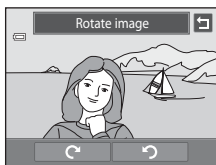

Rotate 90 degrees counterclockwise

The picture rotates 90 degrees.

Tap **OK** to finalize display orientation and save the orientation information with the picture.

To exit without rotating image, tap .

Voice Memo: Recording and Playback

Use the camera's built-in microphone to record voice memos for pictures.

Recording Voice Memos

- 1 Select the desired picture from full-frame playback mode ( 80) and tap the bottom tab.



- 2 Tap .

The screen for recording voice memos is displayed.



- 3 Tap  to record a voice memo.

Recording ends after about 20 seconds.

Do not touch the built-in microphone during recording.

To exit without recording voice memos, tap .

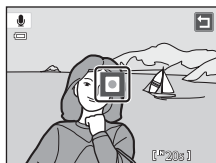

During recording, **REC** blinks in the monitor.

Recording ends when  is tapped during recording.

When recording ends, the voice memo playback screen is displayed. Follow the instructions in step 3 of "Playing Voice Memos" ( 109) to play the voice memo.

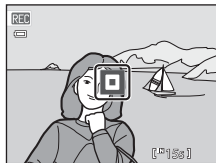

More Information

Playing Voice Memos

Pictures for which voice memos have been recorded are indicated by  in full-frame playback mode.

- 1 Select the desired picture from full-frame playback mode ( 80) and tap the bottom tab.

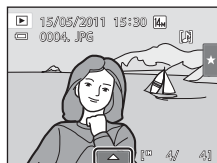

- 2 Tap .

The voice memo playback screen is displayed.



- 3 Tap  to play the voice memo.

Tap  to stop playback.

Tap  during playback to adjust playback volume.

 blinks during playback.

To exit without playing voice memos, tap .



Deleting Voice Memos

Tap  in step 3 of "Playing Voice Memos". Tap **Yes** to delete only the voice memo.

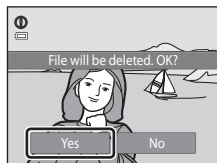

Notes on Voice Memos

- When a picture with a voice memo attached is deleted, both the picture and its voice memo are deleted.
- If a voice memo already exists for the current picture, it must be deleted before a new voice memo can be recorded.
- The COOLPIX S4100 is not able to record a voice memo for pictures taken with another make or model of digital camera.

Editing Functions

Use the COOLPIX S4100 to edit pictures in-camera and store them as separate files (📖 174). The editing functions described below are available.

Editing function	Description
Paint (📖 112)	Draw on pictures, or add decorations, to pictures.
Quick retouch (📖 115)	Easily create retouched copies in which contrast and saturation have been enhanced.
D-Lighting (📖 116)	Create a copy of the current picture with enhanced brightness and contrast, brightening dark portions of the picture.
Stretch (📖 117)	Stretch the current picture horizontally to make the subject appear thinner or wider.
Perspective control (📖 118)	Adjust the perspective of pictures taken in landscape orientation. Apply perspective control similar to that available with shift lenses. This option is suited to pictures of buildings or architecture.
Filter effects (📖 119)	Apply a variety of effects using digital filter. The available effects are Color options , Soft , Selective color , Cross screen , Fisheye , and Miniature effect .
Glamour retouch (📖 121)	Make facial skin tone softer and make faces look smaller with larger eyes.
Small picture (📖 123)	Create a small copy of pictures suitable for use as e-mail attachments.
Crop (📖 124)	Crop a portion of the picture. Use to zoom in on a subject or arrange a composition.

See page 107 for the rotate image function for more information.

✓ Notes on Picture Editing

- Pictures taken at an **Image mode** setting (📖 43) of **4224x2376** cannot be edited.
- The editing functions of COOLPIX S4100 cannot be used for pictures taken with another make or model of digital cameras.
- If no face is detected in a picture, a copy cannot be created using the glamour retouch function (📖 121).
- Edited copies created with COOLPIX S4100 may not be displayed properly on a different model of digital camera. It may also be impossible to transfer them to a computer using a different model of digital camera.
- Editing functions are not available when there is not enough free space in the internal memory or on the memory card to store the edited copies.
- Images created in draw scene mode (📖 71) can only be edited with the paint, small picture, or crop function.

Restrictions on Picture Editing

When an edited copy is further modified with another editing function, check the following restrictions.

Editing function used	Editing function to add
Paint	The paint, small picture, or crop function can be added.
Quick retouch D-Lighting Stretch Perspective control Filter effects	The paint, small picture, glamour retouch, or crop function can be added.
Glamour retouch	The editing functions other than glamour retouch can be added.
Small picture	Another editing function cannot be added.
Crop	Another editing function cannot be added. However, the paint function can be applied to cropped copies saved at an image size of 640 × 480 pixels or larger.

- Copies created with editing functions other than the paint function cannot be further edited with the same function used to create them.
- When combining the small picture or crop function and another editing function, use the small picture and crop functions after other editing functions have been applied.
- Retouch effects such as the glamour retouch function's skin softening effect can be applied to pictures taken with the skin softening function (📖 77).

Original and Edited Pictures

- Copies created with editing functions are not deleted when the original pictures are deleted. The original pictures are not deleted when copies created with editing functions are deleted.
- Edited copies are stored with the same recording date and time as the original.
- The rating settings (📖 99), protect settings (📖 101), and print markings (📖 103) of the original image are not applied to edited copies.

Picture Editing

Paint







Draw on pictures or decorate them. Shooting date decoration can also be added. Painted copies are stored as separate files.

- 1 Select a picture in full-frame playback mode (📖 80), tap the bottom tab to display the setting controls, and tap .



- 2 Use the , , , and  tools to paint pictures.

For more information about using each tool, see “Write and Draw on Pictures” (📖 113).

Tap  to display the picture in full-frame playback mode and tap  again to enlarge the picture display by 3x. Tap , , , or  to change the portion of the picture visible in the monitor. Tap  to return to the original display size.

Tap  to undo the last operation applied using the pen, eraser, or decoration tool (up to the last five operations can be undone).

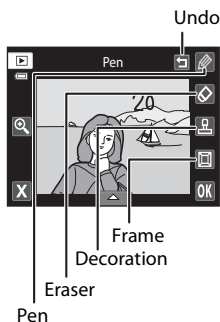

- 3 Tap .

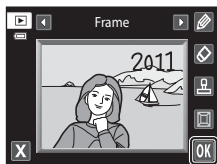

4 Tap **Yes**.

A new, painted copy is created.

Pictures taken at an **Image mode** setting (📖 43) of **2048×1536** or larger are saved at a size of 2048 × 1536 and pictures taken at **PG 1024×768** or **VM 640×480** are saved at a size of 640 × 480.

To exit without saving the copy, tap **No**.

Painted copies can be recognized by the  icon displayed during playback.

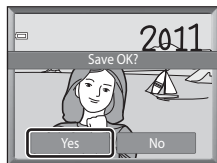

Using the Paint Tools

Write and Draw on Pictures

Tap  to write or draw on pictures.

To change the pens' color or thickness, tap the bottom tab to display the screen shown at right.

- Tap or drag the pen's color slider to select pen's color.
- Tap the pen's thickness slider to select pen's thickness.

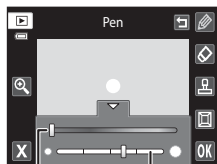

Pen's
color

Pen's
thickness

Erase Paint Tool Additions

Tap  to erase additions to pictures using the paint or decoration tool.

To change the eraser's size, tap the bottom tab to display the screen shown at right.

- Tap the eraser's size slider to select the size of the eraser.

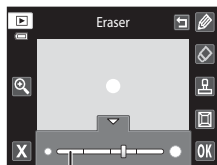



Eraser's size

Add Decorations

Tap  to add a decoration.

To change the decoration type or size, tap the bottom tab to display the screen shown at right.

- Decoration type can be selected from 14 types.
- Tap the decoration size slider to select the decoration size.
- When  is selected for the decoration type,  (day, month, year) and  (day, month, year, time) options are available.



Add a Frame

Tap  to add a frame around the picture.

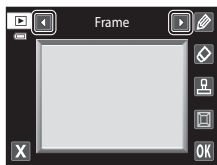
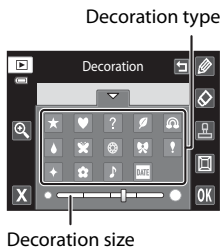
- Tap  or  to display seven different frames one at a time. Tap  to select a frame.



✓ Notes on Shooting Date Decoration



- When the shooting date decoration is added to pictures taken at an **Image mode** setting ( 43) of **Video 640x480**, the shooting date may be difficult to read. Set **Image mode** to **PG 1024x768** or larger when shooting.
- The date added with the shooting date decoration uses the **Date format** setting selected in the setup menu's **Time zone and date** item ( 149).
- The date and time added with the shooting date decoration are the date and time at which the picture was taken. These cannot be changed.

More Information

See "Image/Sound File and Folder Names" ( 174) for more information.

Quick Retouch: Enhancing Contrast and Saturation

Quick retouch can be used to easily create retouched copies in which contrast and saturation have been enhanced. Copies created with the quick retouch function are stored as separate files.

- 1 Select a picture in full-frame playback mode ( 80), tap the bottom tab to display the setting controls, and tap .

The retouch menu is displayed.

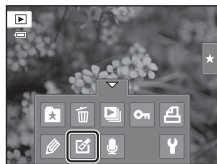

- 2 Tap .

The screen for selecting the degree of enhancement is displayed.



- 3 Choose the degree of enhancement performed and tap .



- 4 Tap **Yes**.

A new retouched copy is created.

To exit without saving the copy, tap **No**.

Copies created with the quick retouch option can be recognized by the  icon displayed in playback mode.





More Information

See "Image/Sound File and Folder Names" ( 174) for more information.

D-Lighting: Enhancing Brightness and Contrast

D-Lighting can be used to create copies with enhanced brightness and contrast, brightening dark portions of a picture. New copies are stored as separate files.

- 1 Select a picture in full-frame playback mode ( 80), tap the bottom tab to display the setting controls, and tap .

The retouch menu is displayed.



- 2 Tap .

The original version will be shown on the left and the edited version will be shown on the right.



- 3 Tap .



- 4 Tap **Yes**.

A new, edited copy is created.

To exit without saving the copy, tap **No**.

Copies created with the D-Lighting function can be recognized by the  icon displayed in playback mode.





More Information

See "Image/Sound File and Folder Names" ( 174) for more information.

Stretch: Stretching Pictures

Stretch pictures horizontally. Stretched copies are stored as separate files.



- 1 Select a picture in full-frame playback mode ( 80), tap the bottom tab to display the setting controls, and tap .

The retouch menu is displayed.

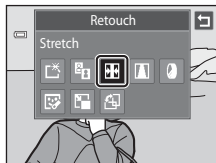

- 2 Tap .



- 3 Tap  or , or tap or drag the slider at the bottom of the screen to adjust stretch effect.

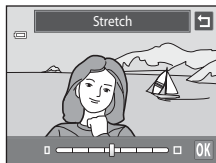

- 4 Tap .

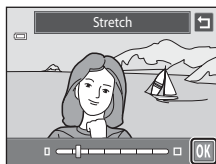

- 5 Tap **Yes**.

A new, stretched copy is created.

To exit without saving the copy, tap **No**.

Stretched copies can be recognized by the  icon displayed in playback mode.

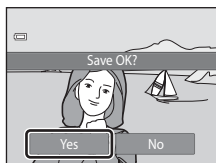



More Information

See "Image/Sound File and Folder Names" ( 174) for more information.

Perspective Control: Adjusting a Sense of Perspective

Adjust the sense of perspective in the picture taken in landscape orientation.

Copies created with the perspective control function are stored as separate files.

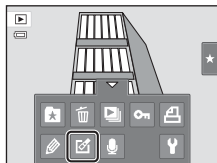

- 1 Select a picture in full-frame playback mode ( 80), tap the bottom tab to display the setting controls, and tap .

The retouch menu is displayed.

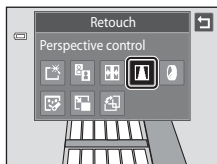

- 2 Tap .



- 3 Tap  or , or tap or drag the slider at the bottom of the screen to adjust perspective control.

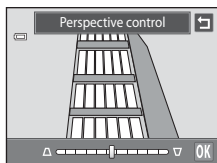

- 4 Tap .

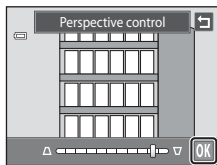

- 5 Tap **Yes**.

A new, edited copy is created.

To exit without saving the copy, tap **No**.

Copies created using the perspective control function can be recognized by the  icon displayed in playback mode.

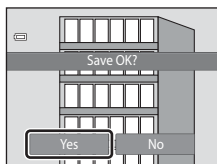



More Information

See "Image/Sound File and Folder Names" ( 174) for more information.

Filter Effects (Digital Filter)

Apply a variety of effects using digital filter. The available effects are **Color options**, **Soft**, **Selective color**, **Cross screen**, **Fisheye**, or **Miniature effect**. New copies are stored as separate files.

- 1 Select a picture in full-frame playback mode ( 80), tap the bottom tab to display the setting controls, and tap .

The retouch menu is displayed.





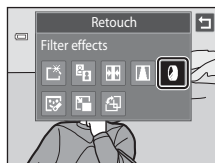

- 2 Tap .

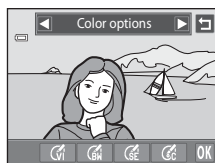

- 3 Tap  or  to select the type of the effects.



Type	Description
Color options	Modify color tones. <ul style="list-style-type: none"> • Select option from  (vivid color),  (black-and-white),  (sepia), or  (cyanotype), and tap OK.

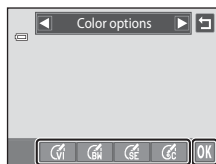

Type	Description
Soft	<p>Give the picture a soft look by blurring the area surrounding the point that is tapped.</p> <ul style="list-style-type: none"> Tap the monitor, select the degree of effects, and tap OK.
Selective color	<p>Keep one specified color in the picture, and change the other colors to black and white.</p> <ul style="list-style-type: none"> Tap the color slider displayed on the screen to select the color to keep, and tap OK.
Cross screen	<p>Produce star-like rays of light that radiate outward from bright objects such as sunlight reflections and city lights. This effect is suitable for night scenes.</p> <ul style="list-style-type: none"> Confirm the degree of enhancement, and tap OK.
Fisheye	<p>Make a picture look as if it were taken with a fisheye lens. This effect is well-suited for pictures taken in macro mode.</p> <ul style="list-style-type: none"> Confirm the degree of enhancement, and tap OK.
Miniature effect	<p>Make a picture look like a miniature scene taken in macro mode. This effect is well-suited for pictures taken from a high vantage point with the main subject at the center of the picture.</p> <ul style="list-style-type: none"> Confirm the degree of enhancement, and tap OK.



A confirmation screen for saving the edited copy is displayed.

Tap  to return to the retouch menu without making any changes.

4 Tap **Yes** in the confirmation dialog.

A new, edited copy is created.

To exit without saving the copy, tap **No**.

Copies created using the filter effects function can be recognized by the  icon displayed in playback mode.

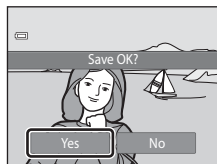



More Information

See "Image/Sound File and Folder Names" ( 174) for more information.

Glamour Retouch

Glamour retouch can be used to soften the skin tone of faces detected in a picture and make the faces look smaller with larger eyes. New copies are stored as separate files.

- 1 Select a picture in full-frame playback mode ( 80), tap the bottom tab to display the setting controls, and tap .

The retouch menu is displayed.



- 2 Tap .

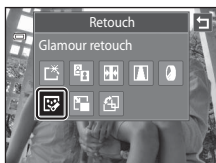

- 3 Tap  (skin softening) or  (both).

: Soften facial skin tones.

: Soften facial skin tones, make faces look smaller, and make eyes look larger.



The preview screen is displayed.



- 4 Preview the result of the effects.

Skin tones in up to 12 faces, in the order of that closest to the center of the frame, are softened.

Tap **Before** or **After** to view the picture with or without the effects.

If more than one face was retouched, tap  or  to display a different face.

To change the effect, tap  to return to step 3.

Tap **OK** to display the confirmation dialog for saving the new copy.

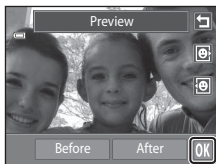

5 Tap **Yes**.

A new, edited copy is created.

To exit without saving the copy, tap **No**.

Copies created using the glamour retouch function can be recognized by the  icon displayed in playback mode.



Notes on Glamour Retouch

- If no faces are detected in the picture, the glamour retouch function cannot be used.
- The glamour retouch function may not perform as expected depending on the direction in which the faces are looking or the brightness of the faces in the picture.

More Information

See "Image/Sound File and Folder Names" ( 174) for more information.

Small Picture: Making Smaller Pictures

Create a small copy of the current picture. This feature is useful for creating copies for display on Web pages or e-mail attachments. Small copies are stored as JPEG files with a compression ratio of 1:16. The  **640×480**,  **320×240**, and  **160×120** sizes are available.

- 1 Select a picture in full-frame playback mode (📖 80), tap the bottom tab to display the setting controls, and tap .

The retouch menu is displayed.



- 2 Tap .

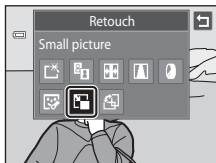

- 3 Tap the desired small copy size control and tap **OK**.



- 4 Tap **Yes**.

A new, small copy is created.

To exit without saving the copy, tap **No**.

The copy is displayed with a gray frame.



More Information

See "Image/Sound File and Folder Names" (📖 174) for more information.

✂ Crop: Creating a Cropped Copy

Create a copy containing only the portion visible in the monitor when ✂ is displayed with playback zoom (📖 83) enabled. Cropped copies are stored as separate files.

- 1 Rotate the zoom control to **T** (🔍) in full-frame playback mode (📖 80) to zoom in on the image.

To crop a picture displayed in “tall” (portrait) orientation, zoom in on the picture until the black bars displayed on the both sides of the monitor disappear. The cropped picture will be displayed in landscape orientation.

To crop the picture in its current “tall” (portrait) orientation, first rotate the picture (📖 107) so that it is displayed in landscape orientation. Next, enlarge the picture for cropping, crop the picture, and then rotate the cropped picture back to “tall” (portrait) orientation.

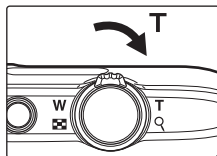

- 2 Refine crop composition.

Rotate the zoom control to **T** (🔍) or **W** (📐) to adjust the zoom ratio.

Drag the picture so that only the portion to be copied is visible in the monitor.



- 3 Tap ✂.



- 4 Tap **Yes**.

A cropped copy is created.

To exit without saving the copy, tap **No**.

Copies created using the crop function can be recognized by the ✂ icon displayed in playback mode.



 **Image Size**

As the area to be saved is reduced, the image size (pixels) of the cropped copy is also reduced. When the size of the cropped copy is 320 × 240 or 160 × 120, a gray frame is displayed around the picture, and the small picture icon  is displayed on the top of the screen in full-frame playback mode.

 **More Information**

See "Image/Sound File and Folder Names" ( 174) for more information.

Recording Movies

Movies with sound can be recorded.

- The maximum file size for a single movie is 2 GB or the maximum movie length for a single movie is 29 minutes, even when there is sufficient free space on the memory card for longer recording (📖 129).
- When no memory card is inserted (when recording in the internal memory), **Movie options** (📖 128) is set to **VGA (640×480)** by default. **HD 720p (1280×720)** cannot be selected.

1 Turn on the camera and be sure that it is in shooting mode.

Movies can be recorded in any shooting mode (📖 40).



2 Press the **MOVIE** (movie-record) button to start movie recording.

Recording begins after the monitor turns off briefly.

The camera focuses at the center of the frame. Focus areas are not displayed during recording.

When the **Shooting** option in **Monitor settings** (📖 152) in the setup menu is set to **View/hide movie frame**, a frame indicating the area captured in the recorded movie can be displayed before recording starts.

When **HD 720p (1280×720)** (default setting) is selected for **Movie options** (📖 128), monitor display changes to an aspect ratio of 16:9 with movie recording (the area indicated at right is recorded).

The approximate remaining movie length is displayed during recording.

Recording stops automatically when the maximum movie length has been recorded.

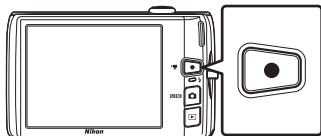

3 Press the **MOVIE** (movie-record) button again to end recording.

✓ Note on Saving Movies

After a movie has been recorded, it is not fully saved to the internal memory or memory card until monitor display returns to the shooting display. **Do not open the battery-chamber/memory card slot cover** before movies have been fully saved. Removing the memory card while movies are being saved could result in loss of data or in damage to the camera or card.

✓ Recording Movies

- Memory cards with an SD Speed Class rating of 6 or faster are recommended when recording movies (📖 173). Movie recording may stop unexpectedly when memory cards with a lower Speed Class ratings are used.
- When **Electronic VR** is set to **Auto** in the setup menu, the angle of view (the area captured in the recorded movie) is smaller than when taking still pictures.
- Optical zoom cannot be adjusted once movie recording begins.
- Rotate the zoom control during recording to enable digital zoom. Subjects can be magnified up to 4x the optical zoom ratio applied before movie recording began.
- There are some degradation in image quality when digital zoom is used. When recording ends, digital zoom is disabled.
- In some cases, movie recordings may capture the sounds of the camera, such as the sounds produced by the zoom control operation, the movement of the lens during autofocus, or the aperture control when the brightness changes.
- Smear (📖 171) visible in the monitor with movie recording will be recorded with movies. Avoiding bright objects such as the sun, reflections of the sun, and electric lights when recording movies is recommended.
- When recording or playing back movies, colored stripes (interference patterns or moiré) may appear on subjects that have a regular, repeating grid, such as pattern of weave in cloths or windows in a building, depending on the shooting distance or zoom ratio. This phenomenon occurs when the subject's pattern interferes with the camera sensor grid, and it does not indicate a malfunction.

✓ Notes on Autofocus for Movie Recording

- When **AF Single AF** (default setting) is selected for **Movie AF mode**, focus is locked by pressing the ● (📷 movie-record) button to start recording (📖 129).
- Autofocus may not perform as expected (📖 31). Should this occur, try the following:
 1. Set **Movie AF mode** to **AF Single AF** (default setting) before starting movie recording.
 2. Frame a different subject (positioned at the same distance from the camera as the intended subject) in the center of the frame, press the ● (📷 movie-record) button to start recording, and then modify the composition.

📷 Functions Available with Movie Recording

- Current exposure compensation setting, white balance setting specified for 📷 (auto) mode, and the scene effect adjustment slider specified for scene mode setting are also applied with movie recording. When macro mode is enabled, movies of subjects closer to the camera can be recorded. Confirm settings before starting movie recording.
- The self-timer (📖 36) can be used. When the ● (📷 movie-record) button is pressed after the self-timer is enabled, the camera focuses at the center of the frame and starts movie recording after the specified two or ten seconds.
- The flash will not fire.
- The **Movie options**, **Movie AF mode**, or **Wind noise reduction** setting can be made before starting movie recording (📖 128).
- To reduce the effects of camera shake, enable electronic VR by setting **Electronic VR** (📖 154) to **Auto** in the setup menu.

Changing the Movie Recording Settings



The movie settings described below can be made. Apply the settings before starting movie recording.

- 📽 **Movie options** 📖 128
 Select the desired movie option for recording movies.
- 📽 **Movie AF mode** 📖 129
 Choose how the camera focuses when recording movies.
- 📽 **Wind noise reduction** 📖 130
 Set whether or not to reduce wind noise during movie recording.

📽 Movie Options



In the shooting screen → Tap the bottom tab (📖 14) → 📽 Movie options

Select the desired movie option to record.

Option	Description
 HD 720p (1280×720) (default setting*)	Movies with an aspect ratio of 16:9 are recorded. This option is suited to playback on a wide screen TV. <ul style="list-style-type: none"> • Image size: 1280 × 720 pixels
 VGA (640×480)	Movies with an aspect ratio of 4:3 are recorded. <ul style="list-style-type: none"> • Image size: 640 × 480 pixels
 QVGA (320×240)	Movies with an aspect ratio of 4:3 are recorded. <ul style="list-style-type: none"> • Image size: 320 × 240 pixels

- * When recording in the internal memory, the default setting is  **VGA (640×480)**.
- The frame rate is approximately 30 frames per second in any options.

Movie Options and Maximum Movie Length

Option	Internal memory (approx. 20 MB)	Memory card ² (4 GB)
 HD 720p (1280×720)	– ¹	15 min
 VGA (640×480)	13 s	45 min
 QVGA (320×240)	43 s	2 h 45 min

All figures are approximate. The maximum recording time may vary by make of memory card.

-  **HD 720p (1280×720)** cannot be selected when recording in the internal memory.
- The maximum file size for a single movie is 2 GB or the maximum movie length for a single movie is 29 minutes, even when there is enough free space on the memory card for a longer movie. The maximum movie length that can be recorded for a single movie is displayed during recording.



More Information

See "Image/Sound File and Folder Names" (📖 174) for more information.

Movie AF Mode

In the shooting screen → Tap the bottom tab (📖 14) →  Movie AF mode

Choose how the camera focuses with recording movies.

Option	Description
 Single AF (default setting)	Focus is locked when the ● (📹 movie-record) button is pressed to start recording. Select this option when the distance between the camera and the subject will remain fairly consistent.
 Full-time AF	Camera focuses continuously during movie recording. Select this option when the distance between the camera and the subject will change. To prevent sound of camera focusing from interfering with recording, use of Single AF is recommended.

 **Wind Noise Reduction**

In the shooting screen → Tap the bottom tab (📖 14) →  Wind noise reduction

Set whether or not to reduce wind noise during movie recording.

Option	Description
ON On	Records while minimizing the noise of wind blowing on the microphone. Suitable for recording in strong winds. During playback, not only wind noise, but other sounds may also become difficult to hear.
OFF Off (default setting)	Wind noise is not reduced.

Movie Playback

In full-frame playback mode (📖 80), movies are recognized by 🎬 icon. Tap 🎬 to play a movie.

To adjust the volume before playback, tap the bottom tab to display the setting controls and tap 🔊.

Tap the monitor during playback to display the playback control panel at the bottom in the monitor. Tap a playback control to perform the corresponding operation. The operations described below are available.



During playback



To	Use	Description
Adjust volume	🔊	Tap 🔊 to adjust volume.
Rewind	⏮	Touch and hold ⏮ to rewind movie.
Advance	⏭	Touch and hold ⏭ to advance movie.
Pause	⏸	Tap ⏸ to pause playback. The following operations can be performed while playback is paused.
		Tap ⏮ to rewind movie one frame. Touch and hold ⏮ for continuous rewinding.
		Tap ⏭ to advance movie one frame. Touch and hold ⏭ for continuous advancing.
		Tap 🎬 displayed at the center of the screen to resume playback.
End	⏹	Tap ⏹ to end movie playback and return to full-frame playback mode.

✔ Movie Playback

Movies recorded by a camera other than the COOLPIX S4100 cannot be played back.

✏ Deleting Movie

See “Deleting Unwanted Pictures” (📖 33) for more information.

Connecting to a TV

Connect the camera to a television using the supplied audio/video cable to play back pictures full-frame or in a slide show, or to play back movies, on a television.

1 Turn off the camera.

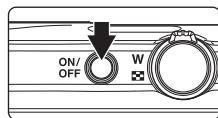

2 Connect the camera to the TV using the supplied audio/video cable.

Connect the yellow plug to the video-in jack and the white plug to the audio-in jack on the TV.

Be sure that the camera connector is properly oriented. Do not use force when connecting the audio/video cable to the camera. When disconnecting the audio/video cable, do not pull the connector at an angle.

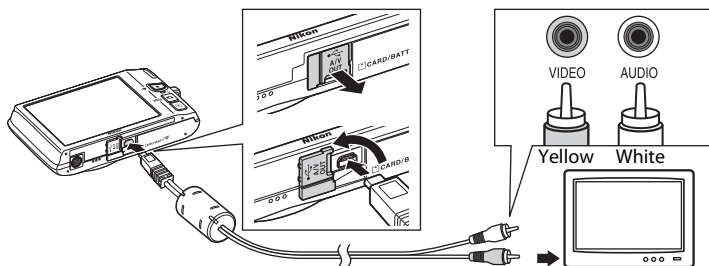

3 Tune the television to the video channel.

See the documentation provided with your television for details.

4 Hold down the button to turn on the camera.

The camera enters playback mode and pictures are displayed on the television.

The camera monitor turns off when pictures are displayed on the television.

See "Operations with TV Connection" ( 133) for more information.

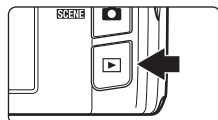



Operations with TV Connection

While pictures are displayed full-frame on the TV, the previous or next picture can be viewed by dragging your finger across the camera monitor.

When the first frame of a movie is displayed, the movie can be played back by holding your finger on the camera monitor and removing it after about one second.

- Tap the camera monitor to turn TV display off and display the picture in the camera monitor. When pictures are displayed in the camera monitor, tap the controls displayed to operate the camera.
- Pictures cannot be cropped.
- Pictures will be automatically displayed on the TV in the following situations.
 - No operations are performed for a few seconds.
 - A slide show is played back.
 - A movie is played back.

Video Mode

Be sure that the camera's video mode setting conforms to the standard used by your television. Specify the **Video mode** setting ( 160) in the setup menu ( 146).

Connecting to a Computer

Use the supplied USB cable to connect the camera to a computer and copy (transfer) images to the computer.

Before Connecting the Camera

Install the Software

Use the supplied ViewNX 2 CD and install the following software on the computer. For more information on installing the software, refer to the *Quick Start Guide*.

- ViewNX 2: Use the image transfer feature “Nikon Transfer 2” to save images that were captured with the camera on the computer. Saved images can be viewed and printed. Image and movie editing features are also supported.
- Panorama Maker 5: This software can join a series of images to create a single panorama image.

Compatible Operating Systems

Windows

Windows 7 Home Basic/Home Premium/Professional/Enterprise/Ultimate, Windows Vista Home Basic/Home Premium/Business/Enterprise/Ultimate (Service Pack 2), or Windows XP Home Edition/Professional (Service Pack 3)

Macintosh

Mac OS X (version 10.4.11, 10.5.8, 10.6.5)

For information on the requirements for playing back high-definition movies, refer to “System Requirements” in the ViewNX 2 help information (📖 138).

Refer to the Nikon website for the latest information on operating system compatibility.

Note on Computer Connection

Disconnect other USB devices such as commercial USB chargers from the computer. Simultaneous connection of the camera and other USB devices to the computer could result in operation malfunction or excessive supply of power to the camera, causing damage to the camera or memory card. Refer to the documentation supplied with other USB devices for more information.

✔ Notes on Power Source

- When connecting the camera to a computer, use a battery with a sufficient amount of charge remaining to prevent the camera from turning off unexpectedly.
- When the camera is connected to a computer via the supplied USB cable with **Auto** (default setting) selected for the **Charge by computer** option in the setup menu, the battery inserted into the camera is automatically charged using power supplied by the computer (139, 161).
- If the AC Adapter EH-62G (172) (available separately) is used, COOLPIX S4100 can be powered from an electrical outlet. Do not use any other make or model of AC adapter as they may cause the camera to overheat or malfunction.

Transferring Images from a Camera to a Computer

- 1 Start the computer to which ViewNX 2 was installed.
- 2 Be sure that the camera is off.
- 3 Connect the camera to the computer using the supplied USB cable.

Be sure that connectors are properly oriented. Do not attempt to insert connectors at an angle, and do not use force when connecting or disconnecting the USB cable.

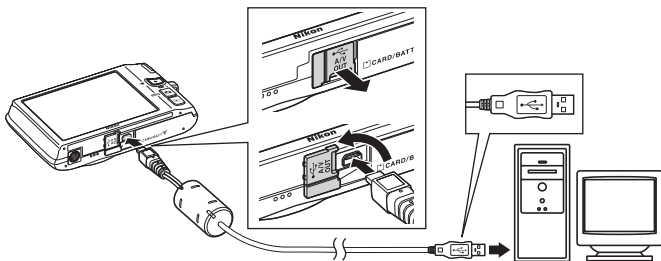

The camera is automatically turned on and the power-on lamp will light. The camera monitor will remain off.

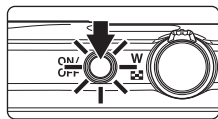

✔ Connecting the USB Cable

The connection may not be recognized if the camera is connected to the computer via a USB hub.

4 Start the ViewNX 2 image transfer feature “Nikon Transfer 2” installed on the computer.

• Windows 7

When the **Devices and Printers** ► **S4100** screen is displayed, click **Change program** under **Import pictures and videos**. Select **Import File using Nikon Transfer 2** in the **Change program** dialog and click **OK**.

Double-click **Import File** on the **Devices and Printers** ► **S4100** screen.

• Windows Vista

When the **AutoPlay** dialog is displayed, click **Import File using Nikon Transfer 2**.

• Windows XP

When the action selection dialog is displayed, select **Nikon Transfer 2 Import File**, and click **OK**.

• Mac OS X

Nikon Transfer 2 will start automatically when the camera is connected to the computer if **Yes** was selected in the **Auto-Launch setting** dialog when ViewNX 2 was first installed.

- See “Starting Nikon Transfer 2 Manually” (📖 138) for more information.

- If charge for the battery inserted into the camera is low, the computer may not recognize the camera. If the camera is not recognized, images will not be transferred. When battery charging starts automatically using power supplied by the computer, wait until battery charge has reached a sufficient level to begin transfer.
- If there are a large number of images on the memory card, it may take some time for Nikon Transfer 2 to start.

5 Confirm that the source device is displayed in the transfer options **Source** panel and click **Start Transfer**.

Source device

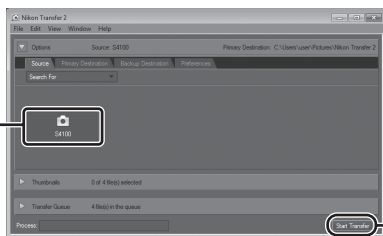

Start Transfer button

Any images that have not been transferred to the computer will be transferred (default setting of ViewNX 2).

When transfer is complete, the ViewNX 2 screen is displayed (ViewNX 2 default setting) and transferred images are displayed.

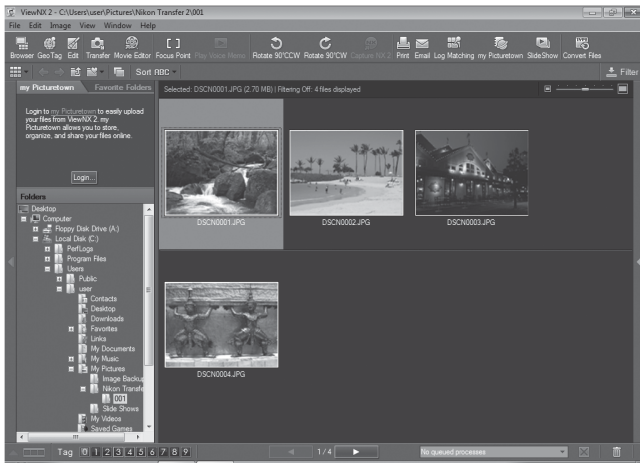

For more information on using ViewNX 2, refer to the ViewNX 2 help information (138).

Disconnecting the Camera

Do not turn off the camera or disconnect the camera from the computer during transfer.

When transfer is complete, turn off the camera and disconnect the USB cable.

The camera turns off automatically if there is no communication with the computer for 30 minutes while the camera is connected via the USB cable.

Charging the Battery

The charge lamp slowly blinks green while the battery inserted into the camera is charging (139).

Transferring Images Using a Computer's Card Slot or a Commercially-available Card Reader

When the memory card is inserted into a computer's card slot or into a commercially-available card reader, the images can be transferred using "Nikon Transfer 2", the image transfer feature of ViewNX 2.

- Make sure that the memory card being used is supported by the card reader or other card reading device.
- To transfer images, insert the memory card into the card reader or card slot and follow the procedure from step 4 (📖 136).
- To transfer images saved in the camera's internal memory, the images must first be copied to a memory card using the camera (📖 167).

Starting ViewNX 2 Manually

Windows

Choose **Start** menu > **All Programs** > **ViewNX 2** > **ViewNX 2**.

Double-clicking the **ViewNX 2** shortcut icon on the desktop will also start ViewNX 2.

Mac OS X

Open the **Applications** folder, open the **Nikon Software** > **ViewNX 2** folders in that order, and then double-click the **ViewNX 2** icon. Clicking the **ViewNX 2** icon on the Dock will also start ViewNX 2.

Starting Nikon Transfer 2 Manually

To start Nikon Transfer 2, first start ViewNX 2, and then click the **Transfer** icon at the top of the screen or select **Launch Transfer** from the **File** menu.

For More Information on Using ViewNX 2 and Nikon Transfer 2

For more information on ViewNX 2 or Nikon Transfer 2, start ViewNX 2 or Nikon Transfer 2 and select **ViewNX 2 Help** from the **Help** menu.

Panorama Creation with Panorama Maker 5

- Use a series of images captured in **Panorama assist** scene mode (📖 72) to create a single panorama photo with Panorama Maker 5.
- Panorama Maker 5 can be installed on a computer using the supplied ViewNX 2 CD.
- After installation is complete, follow the procedure described below to start Panorama Maker 5.

Windows

Choose **Start** menu > **All Programs** > **ArcSoft Panorama Maker 5** > **Panorama Maker 5**.

Mac OS X

Open **Applications** and double-click the **Panorama Maker 5** icon.

- For more information on using Panorama Maker 5, refer to the on-screen instructions and help information contained in Panorama Maker 5.

Image File Names and Folder Names

See "Image/Sound File and Folder Names" (📖 174) for more information.

Charging While Connecting to a Computer

When the **Charge by computer** option (📖 161) in the camera's setup menu is set to **Auto** (default setting), if the camera is connected to a computer using the USB cable, the battery inserted into the camera can be automatically charged depending on the ability of the computer to supply power.

See "Before Connecting the Camera" (📖 134) and "Transferring Images from a Camera to a Computer" (📖 135) for more information on connecting the camera to a computer.

Charge Lamp

The following chart explains charge lamp status when the camera is connected to a computer.

Charge lamp	Description
Blinks slowly (green)	Battery charging.
Off	Battery not charging. If the charge lamp changes from slow blinking (green) to off while the power-on lamp is lit, charging is complete.
Flickers (green)	<ul style="list-style-type: none"> The ambient temperature is not suited to charging. Charge the battery indoors with an ambient temperature of 5°C to 35°C (41°F to 95°F). A USB cable is not correctly connected or the battery is faulty. Reconnect the USB cable correctly or replace the battery. Computer is in sleep mode and does not supply power. Reboot the computer. The battery cannot be charged as computer's specifications or settings does not support power supply to the camera.

🗒️ Notes on Charging with Connection to a Computer

- The battery cannot be charged, nor can data be transferred, when the camera is connected to a computer before the camera's display language and date and time have been set (📖 22). If the camera's clock battery (📖 150) has been exhausted, the date and time must be reset before the battery can be charged or images can be transferred with connection to a computer. In this case, use the Charging AC Adapter EH-69P (📖 18) to charge the battery and then set the camera's date and time.
- If the camera is turned off, charging will also stop.
- If a computer enters sleep mode while charging, charging will stop and the camera may be turned off.
- When disconnecting the camera from a computer, turn the camera off and then disconnect the USB cable.
- It may take longer to charge the battery with connection to a computer than with charging using the Charging AC Adapter EH-69P. Charging time increases when images are transferred while the battery is charging.
- When the camera is connected to a computer, an application installed on the computer, such as Nikon Transfer 2, may start. If the camera was connected to the computer for the sole purpose of charging the battery, exit the application.
- The camera turns off automatically if there is no communication with the computer for 30 minutes after the battery has finished charging.
- Depending upon computer specifications, settings, and power supply and allocation, it may be impossible to charge the battery inserted into the camera via computer connection.

Connecting to a Printer

Users of PictBridge-compatible (📖 190) printers can connect the camera directly to the printer and print pictures without using a computer. Follow the procedures below to print pictures.

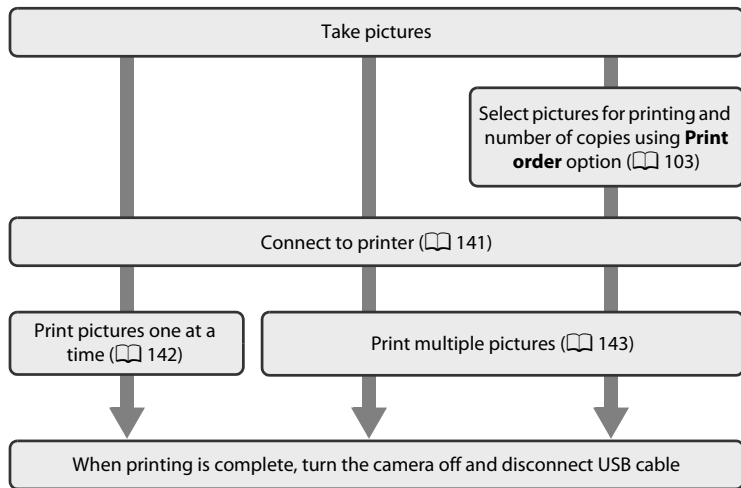

✔ Note on Power Source

When connecting the camera to a printer, use a fully charged battery to prevent the camera from turning off unexpectedly.

If the AC Adapter EH-62G (available separately) is used, COOLPIX S4100 can be powered from an electrical outlet. Do not use any other make or model of AC adapter as they may cause the camera to overheat or malfunction.

📖 Printing Pictures

In addition to printing pictures transferred to a computer from your personal printer and printing over a direct camera-to-printer connection, the following options are also available for printing pictures:

- Inserting a memory card into a DPOF-compatible printer's card slot
- Taking a memory card to a digital photo lab

For printing using these methods, specify the pictures and the number of prints each to the memory card using the **Print order** menu (📖 103).

Connecting the Camera to a Printer

- 1 Turn off the camera.

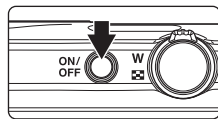

- 2 Turn on the printer.

Check printer settings.

- 3 Connect the camera to the printer using the supplied USB cable.

Be sure that connectors are properly oriented. Do not attempt to insert connectors at an angle, and do not use force when connecting or disconnecting the USB cable.

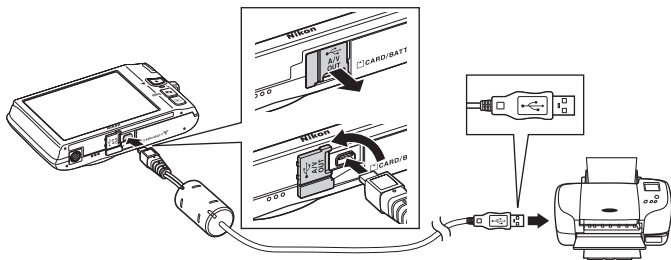

- 4 The camera is automatically turned on.

When properly connected, the **PictBridge** startup screen (①) will be displayed in the camera monitor, followed by the **Print selection** screen (②).

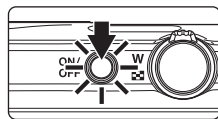

✔ If the PictBridge Startup Screen Is not Displayed

Turn the camera off and disconnect the USB cable. Set the **Charge by computer** option (📖 161) in the camera's setup menu to **Off** and reconnect the cable.

Printing Pictures One at a Time

After properly connecting the camera to the printer (📖 141), follow the procedure described below to print a picture.

- 1 Tap **▲** or **▼** to choose the desired picture and tap **OK**.

Tap **🔍** or rotate the zoom control to **W** (🗍) to switch to 9-thumbnail display. Tap **🔍** or rotate the zoom control to **T** (📺) to switch back to full-frame playback.

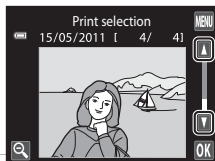

- 2 Tap **Copies**.

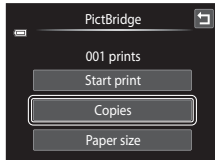

- 3 Tap the desired number of copies (up to nine).

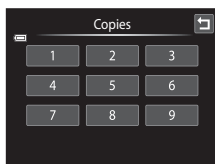

- 4 Tap **Paper size**.

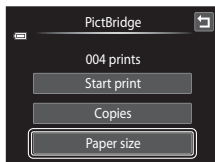

5 Tap the desired paper size.

Tap **A** or **V** to display additional options.

To specify paper size using printer settings, choose **Default** in the paper size menu.

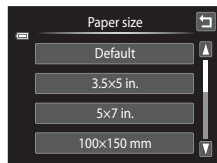
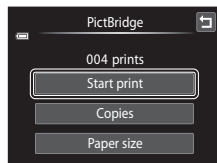
**6** Tap **Start print**.**7** Printing begins.

Monitor display returns to the print selection screen shown in step 1 when printing is complete.

To cancel printing before all copies have been printed, tap **Cancel**.

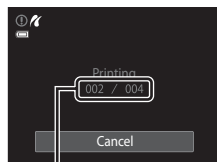

Current number of copies/
total number of prints

Printing Multiple Pictures

After properly connecting the camera to the printer (141), follow the procedure described below to print multiple pictures.

1 When the **Print selection** screen is displayed, tap **MENU**.

The **Print menu** screen is displayed.

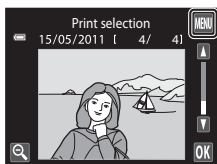
**2** Tap **Paper size**.

To exit the print menu, tap **OK**.

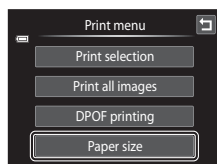

3 Tap the desired paper size.

Tap **A** or **I** to display additional options.

To specify paper size using printer settings, choose **Default** in the paper size option.

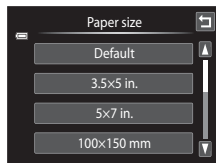
**4** Tap **Print selection**, **Print all images**, or **DPOF printing**.**Print selection**

Choose pictures (up to 99) and the number of copies (up to nine) of each.

- Tap the desired picture and tap **A** or **I** at the upper left in the monitor to specify the number of copies to be printed.
- Pictures selected for printing can be recognized by the check mark (✓) and the numeral indicating the number of copies to be printed. If no copies have been specified for pictures, the selection is canceled.
- Tap **Z** or rotate the zoom control to **T** (Q) to switch to full-frame playback. Tap **Q** or rotate the zoom control to **W** (R) to switch back to 9-thumbnail display.
- Tap **ESC** to cancel the selection of all pictures.
- Tap **OK** when setting is complete.
- When the screen shown at right is displayed, tap **Start print** to start printing. Tap **Cancel** to return to the print menu.

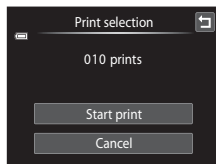
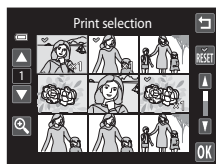

Print all images

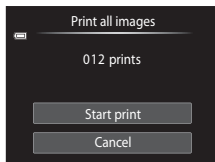

One copy each of all pictures stored in the internal memory, or on the memory card, is printed.

- When the screen shown at right is displayed, tap **Start print** to start printing. Tap **Cancel** to return to the print menu.



DPOF printing

Print pictures for which a print order was created using the **Print order** option (📖 103).

- When the screen shown at right is displayed, tap **Start print** to start printing. Tap  to return to the print menu.
- To view the current print order, tap **View images**. To print pictures, tap .

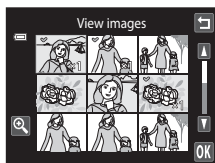
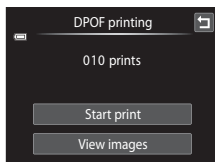

5 Printing begins.

Monitor display returns to the print menu (step 2) when printing is complete.

To cancel printing before all copies have been printed, tap **Cancel**.

















Current number of copies/
total number of prints







Paper Size

The camera supports the following paper sizes: **Default** (the default paper size for the printer connected to the camera), **3.5x5 in.**, **5x7 in.**, **100x150 mm**, **4x6 in.**, **8x10 in.**, **Letter**, **A3**, and **A4**. Only sizes supported by the printer will be displayed. To specify paper size using printer settings, choose **Default** in the paper size option.

Setup Menu

The setup menu contains the following options.

	Welcome screen 📖 148
	Choose whether or not a welcome screen is displayed when camera is turned on.
	Time zone and date 📖 149
	Set camera clock and choose home and destination time zones.
	Monitor settings 📖 152
	Set the options for items displayed in the monitor during shooting or playback, the image review settings, and the monitor brightness.
	Print date 📖 153
	Imprint shooting date and time on pictures.
	Electronic VR 📖 154
	Choose whether or not electronic vibration reduction is enabled when taking still pictures.
	Motion detection 📖 155
	Enable or disable motion detection, which reduces the effects of subject movement and camera shake in still pictures.
	AF assist 📖 156
	Enable or disable AF-assist illuminator.
	Digital zoom 📖 156
	Enable or disable digital zoom.
	Sound settings 📖 157
	Adjust sound settings.
	Auto off 📖 158
	Set time before the monitor turns off for saving power.
	Format memory/Format card 📖 159
	Format internal memory or memory card.
	Language 📖 160
	Choose the language used for camera monitor display.
	Video mode 📖 160
	Adjust settings necessary for connection to television.
	Charge by computer 📖 161
	Choose whether or not to charge the camera battery when connecting to a computer via the USB cable.

	Blink warning	 162
Specify whether or not the camera detects human subjects that have blinked with shooting using the face detection function.		
	Reset all	 164
Restore camera settings to default values.		
	Copy	 167
Copy files between memory card and internal memory.		
Vet	Firmware version	 168
Display camera firmware version.		

Operating the Setup Menu

- 1 Tap the bottom tab in shooting or playback mode.
See "Operating the Tabs" ( 14) for more information.



- 2 Tap the **Y** tab.
The setup menu is displayed.

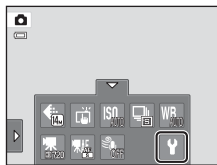

- 3 Tap the desired option.

Tap  or  to display the previous or next page.

Tap  to return to the previous screen.

When **OK** is displayed in a screen, tap **OK** to apply the setting.

To exit the setup menu, tap  or press the shutter-release button (when shooting).

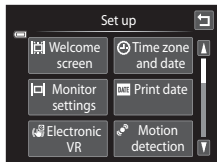

Welcome Screen

Tap the bottom tab (📖 147) → Tap **Y** (Setup menu) → **Welcome screen**

Choose whether or not a welcome screen is displayed when the camera is turned on.

None (default setting)

The camera enters shooting or playback mode without displaying the welcome screen.

COOLPIX

The camera displays a welcome screen and enters shooting or playback mode.

Select an image

Displays a picture selected for the welcome screen. When the **Select image** screen is displayed, select a picture and tap **OK**.

- In the **Select image** screen, tap **Q** or rotate the zoom control to **T** (📄) to switch to full-frame playback and tap **Q** or rotate the zoom control to **W** (📄) to switch back to 9-thumbnail display.
- As the selected picture is stored by the camera, it will be displayed when the camera is turned on even if the original picture is deleted.
- Pictures taken at an **Image mode** setting (📖 43) of **4224×2376**, and copies created at a size of 320 × 240 or smaller using small picture (📖 123) or the crop (📖 124) function, cannot be used.



⌚ Time Zone and Date

Tap the bottom tab (📖 147) → Tap 📌 (Setup menu) → ⌚ Time zone and date

Set the camera clock.

Date and time

Set camera clock to current date and time.
Tap the items on the displayed screen to set the date and time.

- Select the item: tap the desired item.
- Edit the highlighted item: tap ▲ or ▼.
- Apply the setting: tap **OK**.

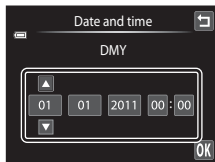

Date format

Select the order in which the day, month, and year are displayed from **Y/M/D** (year/month/day), **M/D/Y** (month/day/year), and **D/M/Y** (day/month/year).

Time zone

🏠 **Home time zone** can be specified and daylight saving is enabled or disabled from **Time zone** options. When **Travel destination** (📍) is selected, local time (📖 151) is automatically calculated and the date and time in the selected region are recorded with pictures. Useful when traveling.

Selecting Travel Destination Time Zone

1 Tap **Time zone**.

The **Time zone** menu is displayed.

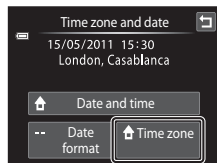

2 Tap 📍 **Travel destination**.

The date and time displayed in the monitor changes according to the region currently selected.

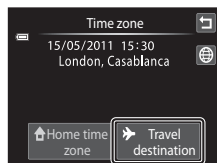

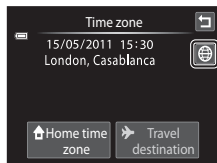

3 Tap .

The time zone selection screen is displayed.



4 Tap or to choose the travel destination time zone and tap **OK**.

If daylight saving time is in effect, tap  to enable daylight saving time function.  is displayed at the top of the monitor and the camera clock is advanced one hour. Tap  again to disable the daylight saving time function.





While the travel destination time zone is selected, the  icon will be displayed in the monitor when the camera is in shooting mode.

Note on the Clock Battery

The camera clock is powered by the clock battery. The clock battery charges when the main battery is inserted or an AC adapter is connected, and can provide several days of backup power after about ten hours of charging.

Home Time Zone

- To switch to the home time zone, tap  **Home time zone** in step 2.
- To change the home time zone, tap  **Home time zone** in step 2 and complete steps 3 and 4.

Daylight Saving Time

When daylight saving time starts or ends, turn the daylight saving time option on or off from the time zone selection screen displayed in step 4.

Imprinting Date on Pictures

Enable the **Print date** option ( 153) in the setup menu after the date and time have been set. When the **Print date** option is enabled, pictures will be recorded with shooting date imprinted on them.

 **Time Zones**

The camera supports the time zones listed below.

For time zones not listed below, set the camera clock to local time from the **Date and time** option.

UTC +/-	Location	UTC +/-	Location
-11	Midway, Samoa	+1	Madrid, Paris, Berlin
-10	Hawaii, Tahiti	+2	Athens, Helsinki, Ankara
-9	Alaska, Anchorage	+3	Moscow, Nairobi, Riyadh, Kuwait, Manama
-8	PST (PDT): Los Angeles, Seattle, Vancouver	+4	Abu Dhabi, Dubai
-7	MST (MDT): Denver, Phoenix	+5	Islamabad, Karachi
-6	CST (CDT): Chicago, Houston, Mexico City	+5.5	New Delhi
-5	EST (EDT): New York, Toronto, Lima	+6	Colombo, Dhaka
-4.5	Caracas	+7	Bangkok, Jakarta
-4	Manaus	+8	Beijing, Hong Kong, Singapore
-3	Buenos Aires, Sao Paulo	+9	Tokyo, Seoul
-2	Fernando de Noronha	+10	Sydney, Guam
-1	Azores	+11	New Caledonia
±0	London, Casablanca	+12	Auckland, Fiji

Monitor Settings

Tap the bottom tab (📖 147) → Tap  (Setup menu) →  Monitor settings

Set the options below.

Shooting

Select whether or not to display a reference frame or grid in the monitor during shooting.

View/hide movie frame



View/hide framing grid



- **View/hide movie frame:** A frame indicating the angle of view (the area captured in the recorded movie) is displayed before recording starts.
- **View/hide framing grid:** A framing grid is displayed as a reference for framing a picture. The grid is not displayed when recording movies.
- **Off** (default setting): Neither of the above is displayed.

Playback

Set the photo information displayed in the monitor during playback. See "Playback (Information Display)" (📖 12) for more information.

- **Show info:**



- **Auto info** (default setting): Current settings and operational guides are displayed as in **Show info** above. If no operations are performed for a few seconds, information is hidden. Information will be displayed again when the next operation is performed.

Image review

- **On** (default setting): Picture is automatically displayed in the monitor immediately after it is taken and the monitor display returns to shooting mode.
- **Off:** Picture is not displayed after it is taken.

Brightness

Choose from five settings for monitor brightness. The default setting is **3**.

DATE Print Date (Imprinting Date and Time)

Tap the bottom tab (📖 147) → Tap **Y** (Setup menu) → **DATE** Print date

The shooting date and time can be imprinted on the pictures with shooting, allowing the information to be printed even from printers that do not support date printing (📖 106).



DATE Date

Date is imprinted on pictures.

DATE Date and time

Date and time are imprinted on pictures.

Off (default setting)

Date and time are not imprinted on pictures.

At settings other than **Off** the icon for the current setting is displayed in the monitor (📖 10).



✓ Notes on Print Date

- Imprinted dates form a permanent part of image data and cannot be deleted. The date and time cannot be imprinted on pictures after they have been taken.
- The date is not imprinted in the following situations:
 - Pictures taken in **Panorama assist** scene mode
 - Movies
- Dates imprinted at an **Image mode** setting (📖 43) of **VGA 640×480** may be difficult to read. Choose an **Image mode** setting of **PC 1024×768** or larger when using the **Print date** option.
- The date is recorded using the format selected in the setup menu's **Time zone and date** item (📖 22, 149).

✍ Print Date and Print Order



If using a DPOF-compatible printer that supports the printing of shooting date and photo information, it is possible to use the **Print order** option (📖 103) to print such information even on pictures that were not taken using the **Print date** option.

Electronic VR

Tap the bottom tab ( 147) → Tap  (Setup menu) →  Electronic VR

Choose whether or not to use electronic VR (vibration reduction), which reduces the effects of camera shake during shooting.

Auto

When taking still pictures, electronic VR is enabled when  ( 10) is displayed in the monitor and all of the conditions below are met.











- The flash is turned off or set to slow sync mode.
- A slow shutter speed is used.
- **Continuous** is set to **Single**.
- The subject is dark.

When recording movies, electronic VR is enabled at all times.

Off (default setting)

Electronic VR is disabled.

Notes on Electronic Vibration Reduction

- The effectiveness of electronic VR decreases as camera shake increases.
- The pictures taken using electronic vibration reduction may be somewhat “grainy” in appearance.
- Electronic VR does not function under the following conditions or in the following shooting modes:
 - When slow sync with red-eye reduction ( 64, 65) is used
 - When exposure exceeds a certain length of time
 - When **ISO sensitivity** ( 53) is set to **Auto**
 - When **Blink proof** ( 77) is set to **On** in smart portrait mode
 - In the following scene modes: **Sports** ( 64), **Night portrait** ( 64), **Dusk/dawn** ( 66), **Night landscape** ( 66), **Museum** ( 68), **Fireworks show** ( 68), and **Backlighting** ( 69)
- The angle of view (the area captured in the recorded movie) is smaller when electronic VR is enabled during movie recording.

Motion Detection

Tap the bottom tab (📖 147) → Tap  (Setup menu) →  Motion detection

Enable motion detection to reduce the effects of subject movement and camera shake when shooting still pictures.

Auto (default setting)

When the camera detects the subject movement or camera shake, the ISO sensitivity and shutter speed are automatically increased to reduce blurring. However, motion detection does not function in the following situations.

- **Subject tracking** is selected for the touch shooting setting
- When the flash fires
- When **ISO sensitivity** (📖 53) is set to **Fixed range auto**, or ISO sensitivity is fixed at a particular value in  (auto) mode
- When **Multi-shot 16** (📖 54) is selected
- When **Sports** (📖 64), **Night portrait** (📖 64), **Dusk/dawn** (📖 66), **Night landscape** (📖 66), **Museum** (📖 68), **Fireworks show** (📖 68), or **Backlighting** (📖 69) scene mode is enabled

Off

Motion detection is not enabled.

The current motion detection setting can be confirmed in the camera monitor with shooting (📖 10, 27). The motion detection icon turns green when the camera detects camera shake and increases shutter speed. When **Off** is selected, no icon is displayed.

Notes on Motion Detection

- Motion detection may be unable to completely eliminate the effects of subject movement and camera shake in some situations.
- Motion detection may not function if the subject exhibits significant movement or is too dark.
- The pictures taken using motion detection may be somewhat “grainy” in appearance.

AF Assist

Tap the bottom tab ( 147) → Tap  (Setup menu) →  AF assist

Enable or disable AF-assist illumination, which assists autofocus operation when the subject is dimly lit.

Auto (default setting)

AF-assist illumination will be used to assist the focus operation when the subject is dimly lit. The illuminator has a range of about 1.9 m (6 ft. 3 in.) at the maximum wide-angle position and about 1.1 m (3 ft. 7 in.) at the maximum telephoto position. Note that for some scene modes or focus areas, AF-assist illuminator may not light up.

Off



AF-assist illuminator does not light up. The camera may be unable to focus under dim lighting.

Digital Zoom

Tap the bottom tab ( 147) → Tap  (Setup menu) →  Digital zoom

Enable or disable digital zoom.

On (default setting)

When the camera is zoomed in to the maximum optical zoom position, rotating the zoom control to **T** () triggers digital zoom ( 29).

Off

Digital zoom will not be activated (except during movie recording).

Notes on Digital Zoom

- When digital zoom is in effect, the camera focuses at the center of the frame.
- Digital zoom cannot be used in the following situations.
 - When **Subject tracking** is selected for touch shooting
 - When **Scene auto selector, Portrait, Night portrait,** or **Pet portrait** scene mode is selected
 - When smart portrait mode is selected
 - When **Multi-shot 16** ( 54) is selected

🔊 Sound Settings

Tap the bottom tab (📖 147) → Tap  (Setup menu) → 🔊 Sound settings

Adjust the following sound settings.

Button sound

Select **On** (default setting) or **Off**.

When **On** is selected, a beep will sound once when operations are completed successfully, twice when the camera acquires focus on the subject, and three times when an error is detected. Start-up sound will also play when the camera is turned on.

Shutter sound

Select **On** (default setting) or **Off**.

No sound is played with shutter release when some features such as continuous shooting or BSS (best shot selector) are enabled, or when shooting in **Pet portrait** scene mode or recording movies, even if **On** is selected.



Auto Off

Tap the bottom tab ( 147) → Tap  (Setup menu) →  Auto off

When the camera is on and a period of time passes without any operations having been performed, the monitor will be turned off and the camera will enter standby mode ( 21) to save power.

In this option, set the time allowed to elapse before the camera enters standby mode. **30 s**, **1 min** (default setting), **5 min**, and **30 min** can be selected.

When the Monitor Turns off for the Power Saving Function





- Power-on lamp blinks in standby mode.
- Camera turns off after three minutes passes in standby mode.
- To reactivate the monitor while the power on lamp is blinking, press any of the following buttons:
 - The power switch, shutter-release button,  button, or  button

Auto Off Settings

The time allowed to elapse before the camera enters standby mode is fixed in the following situations:

- When a setting screen, mode selection menu, or setup menu is displayed: three minutes
- During slide show playback: up to 30 minutes
- When the AC adapter EH-62G is connected: 30 minutes

Format Memory/Format Card

Tap the bottom tab ( 147) → Tap  (Setup menu) →
 Format memory/ Format card

Use this option to format the internal memory or a memory card.

Formatting the internal memory or memory cards permanently deletes all data.

Deleted data cannot be recovered. Be sure to transfer important pictures to a computer before formatting.

Formatting the Internal Memory

To format the internal memory, remove the memory card from the camera.

The **Format memory** option is displayed in the setup menu.

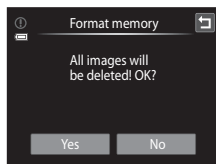

Formatting a Memory Card

When a memory card is inserted in the camera, the **Format card** option is displayed in the setup menu.

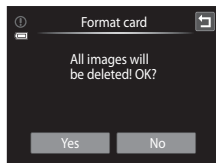

Formatting Internal Memory and Memory Cards

- Formatting the internal memory or memory card restores album icon settings ( 91) to the default setting (displayed as number).
- Do not turn the camera off or open the battery-chamber/memory card slot cover during formatting.
- Be sure to use this camera to format memory cards previously used in other devices the first time they are inserted into the COOLPIX S4100.

Language



Tap the bottom tab (📖 147) → Tap  (Setup menu) →  Language

Choose one of 26 languages for display of camera menus and messages.

Čeština	Czech
Dansk	Danish
Deutsch	German
English	(default setting)
Español	Spanish
Ελληνικά	Greek
Français	French
Indonesia	Indonesian
Italiano	Italian
Magyar	Hungarian
Nederlands	Dutch
Norsk	Norwegian
Polski	Polish



Português	Portuguese
Русский	Russian
Română	Romanian
Suomi	Finnish
Svenska	Swedish
Türkçe	Turkish
Українська	Ukrainian
عربي	Arabic
简体中文	Simplified Chinese
繁體中文	Traditional Chinese
日本語	Japanese
한글	Korean
ภาษาไทย	Thai

Video Mode

Tap the bottom tab (📖 147) → Tap  (Setup menu) →  Video mode

Adjust video mode settings for connection to a television. Select from **NTSC** and **PAL**.

Charge by Computer

Tap the bottom tab ( 147) → Tap  (Setup menu) →  Charge by computer

Choose whether or not the battery inserted into the camera is charged when the camera is connected to a computer via the USB cable ( 139).

Auto (default setting)

When the camera is connected to a computer that is running, the battery inserted into the camera is automatically charged using power supplied by the computer.

Off

The battery inserted into the camera is not charged when the camera is connected to a computer.

Notes on Connecting the Camera to a Printer

- The battery cannot be charged with connection to a printer, even if the printer complies with the PictBridge standard.
- When **Auto** is selected for **Charge by computer**, it may be impossible to print pictures with direct connection of the camera to some printers. If the **PictBridge** startup screen is not displayed in the monitor after the camera is connected to a printer and turned on, turn the camera off and disconnect the USB cable. Set **Charge by computer** to **Off** and reconnect the camera to the printer.

Blink Warning

Tap the bottom tab ( 147) → Tap  (Setup menu) →  Blink warning

Specify whether or not the camera detects human subjects that have blinked when shooting with face detection ( 41) in the following modes.

-  (auto) mode ( 26).
- **Scene auto selector** ( 61), **Portrait** ( 63), or **Night portrait** ( 64) is selected for the scene mode.

On

When the camera detects that one or more human subjects may have blinked in a picture taken using the face detection function, the blink warning screen is displayed in the monitor.

The face of the human subject that may have blinked when the shutter was released is framed by a yellow border. Should this occur, check the picture and determine whether or not another picture should be taken.

See "Operating the Blink Warning Screen" ( 163) for more information.

Off (default setting)

Blink warning is not enabled.

Note on Blink Warning

The blink warning does not function at continuous settings of **Continuous**, **BSS**, or **Multi-shot 16**.

Operating the Blink Warning Screen

When the blink warning screen shown at right is displayed in the monitor, the operations described below are available.

If no operations are performed within a few seconds, the camera automatically returns to shooting mode.







To	Use	Description
Enlarge the detected face that blinked	T (Q)	Rotate the zoom control to T (Q). If the camera detects that more than one human subject blinked, tap or to switch display to another face.
Switch to full-frame playback	W (checkered flag)	Rotate the zoom control to W (checkered flag).
Delete the picture		Tap .
Switch to shooting mode	OK	Tap the monitor or OK . The shutter-release button can also be pressed to return to shooting mode.

Reset All







Tap the bottom tab ( 147) → Tap  (Setup menu) →  Reset all

When **Reset** is selected, the camera's settings will be restored to their default values.



Basic Shooting Functions

Option	Default value
Flash mode ( 34)	Auto
Self-timer ( 36)	Off
Macro mode ( 38)	Off
Exposure compensation ( 39)	0



Auto Mode Shooting Mode

Option	Default value
Image mode ( 43)	 4320×3240
Touch shooting ( 45, 50, 48)	Touch shutter
ISO sensitivity ( 53)	Auto
Continuous ( 54)	Single
White balance ( 55)	Auto



Scene Mode

Option	Default value
Scene effect adjustment slider ( 60)	Center
Continuous in pet portrait mode ( 70)	Continuous
Pet portrait auto release in pet portrait mode ( 70)	On

Smart Portrait Mode

Option	Default value
Skin softening ( 77)	Normal
Blink proof ( 77)	Off
Smile timer ( 77)	On

Movie

Option	Default value
Movie options (📖 128)	When inserting a memory card:  HD 720p (1280x720) When using the internal memory:  VGA (640x480)
Movie AF mode (📖 129)	Single AF
Wind noise reduction (📖 130)	Off

Setup Menu

Option	Default value
Welcome screen (📖 148)	None
Shooting (📖 152)	Off
Playback (📖 152)	Auto info
Image review (📖 152)	On
Brightness (📖 152)	3
Print date (📖 153)	Off
Electronic VR (📖 154)	Off
Motion detection (📖 155)	Auto
AF assist (📖 156)	Auto
Digital zoom (📖 156)	On
Button sound (📖 157)	On
Shutter sound (📖 157)	On
Auto off (📖 158)	1 min
Charge by computer (📖 161)	Auto
Blink warning (📖 162)	Off

Others

Option	Default value
Paper size (📖 142, 143)	Default
Frame interval for slide show (📖 100)	3 s
Slide show effects (📖 100)	Classic

- Selecting **Reset** also clears the current file number (📖 174) from memory. Numbering will continue from the lowest number available. To reset file numbering to "0001", delete all pictures stored in the internal memory or on the memory card (📖 33) before selecting **Reset**.
- The following menu settings will remain unaffected when menus are reset with **Reset all**.

Shooting settings: Preset manual data (📖 56) acquired for **White balance**
 Setup menu: **Time zone and date** (📖 149), **Language** (📖 160), and **Video mode** (📖 160)

Copy (Copy Between Internal Memory and Memory Card)

Tap the bottom tab (📖 147) → Tap **Y** (Setup menu) → **Copy**

Copy pictures between the internal memory and a memory card.

1 Tap the desired option from the copy screen.

IN → **IC**: Copy pictures from internal memory to memory card.

IC → **IN**: Copy pictures from memory card to internal memory.

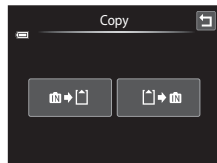

2 Tap the desired copy option.

Selected images: Copy pictures selected. Proceed to step 3.

All images: Copy all pictures. When a confirmation dialog is displayed, tap **Yes**. Pictures are copied. To return to the setup menu without copying, tap **No**.

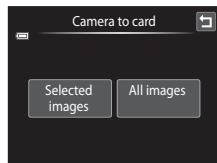

3 Tap the pictures to be copied.

When a picture is selected, a check mark is displayed. To cancel the selection, tap the picture again. A check mark is removed.

Tap **Q** or rotate the zoom control to **T** (Q) to switch to full-frame playback and tap **Q** or rotate the zoom control to **W** (Q) to switch back to 9-thumbnail display.

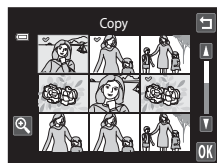

4 Tap **OK**.

When a confirmation dialog is displayed, tap **Yes**. Pictures are copied. To return to the setup menu without copying, tap **No**.



Notes on Copying Pictures

- JPEG-, AVI-, and WAV-format files can be copied. Files recorded in any other format cannot be copied.
- If voice memos (📖 108) are attached to pictures selected for copying, voice memos are copied with the pictures.
- Operation is not guaranteed with pictures taken with another make of camera or that have been modified on a computer.
- When copying pictures selected for **Print order** (📖 103), the print marking is not copied. However, rating (📖 99) and **Protect** (📖 101) settings are copied with pictures.
- Pictures or movies copied from the internal memory to a memory card, or vice versa, cannot be displayed in auto sort mode (📖 93).
- When pictures added to albums (📖 86) are copied, the copies are not automatically added to the same albums as the original pictures.

"Memory contains no images." Message

If there are no pictures stored on a memory card inserted in the camera when playback mode is applied, the message **Memory contains no images.** will be displayed. Perform the followings to copy pictures in the internal memory to a memory card.

1. Tap the bottom tab to display the setting controls and tap .
2. Tap **Copy** in the displayed setup menu.

More Information

See "Image/Sound File and Folder Names" (📖 174) for more information.

Ver. Firmware Version

Tap the bottom tab (📖 147) → Tap  (Setup menu) → **Ver.** Firmware version

View the current camera firmware version.

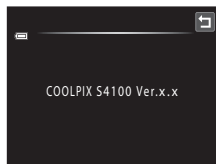

Maximizing Camera Life and Performance

To ensure continued enjoyment of this Nikon product, observe the following precautions when using or storing the device.

Keep dry

The device will be damaged if immersed in water or subjected to high humidity.

Do not drop

The product may malfunction if subjected to strong shock or vibration.

Handle the lens and all moving parts with care

Do not apply force to the lens, lens cover, monitor, memory card slot or battery chamber. These parts are easily damaged. Applying force to the lens cover could result in camera malfunction or damage to the lens. Should the monitor break, care should be taken to avoid injury caused by broken glass and to prevent the liquid crystal from the display touching the skin or entering the eyes or mouth.

Do not point the lens at strong light sources for extended periods

Avoid pointing the lens at the sun or other strong light sources for extended periods when using or storing the camera. Intense light may cause deterioration of the CCD image sensor, producing a white blur effect in photographs.

Keep away from strong magnetic fields

Do not use or store this device in the vicinity of equipment that generates strong electromagnetic radiation or magnetic fields. Strong static charge or the magnetic fields produced by equipment such as radio transmitters could interfere with the monitor, damage data stored on the memory card, or affect the product's internal circuitry.

Avoid sudden changes in temperature

Sudden changes in temperature, such as when entering or leaving a heated building on a cold day, can cause condensation to form inside the device. To prevent condensation, place the device in a carrying case or a plastic bag before exposing it to sudden changes in temperature.

Turn the product off before removing or disconnecting the power source

Do not remove the battery while the product is on, or while images are being recorded or deleted. Forcibly cutting power in these circumstances could result in loss of data or in damage to product memory or internal circuitry.

The Battery

- Check the battery level before using the camera and replace or charge the battery if necessary. Do not continue charging once the battery is fully charged as this will result in reduced battery performance. Whenever possible, carry a fully charged spare battery when taking pictures on important occasions.
- Do not use the battery at ambient temperatures below 0°C (32°F) or above 40°C (104°F). Failure to observe this precaution could damage the battery or impair its performance.
- When charging the battery inserted into the COOLPIX S4100 using the Charging AC adapter EH-69P or a computer, the battery is not charged at battery temperatures below 0°C (32°F) or above 45°C (113°F).
- Note that the battery may become hot during use; wait for the battery to cool before charging. Failure to observe these precautions could damage the battery, impair its performance, or prevent it from charging normally.
- On cold days, the capacity of batteries tends to decrease. Be sure that the battery is fully charged before heading outside to take pictures in cold weather. Keep spare batteries in a warm place and exchange as necessary. Once warmed, a cold battery may recover some of its charge.
- Dirt on the battery terminals can prevent the camera from functioning. Should the battery terminals become dirty, wipe them off with a clean, dry cloth before use.
- If the battery will not be used for some time, insert it in the camera and run it flat before removing it for storage. The battery should be stored in a cool location with an ambient temperature of 15°C to 25°C (59°F to 77°F). Do not store the battery in hot or extremely cold locations.
- Always remove the battery from the camera or optional battery charger when it is not being used. When inserted, minute amounts of current are drawn from the battery even when not in use. This may result in excessive draining of the battery and complete loss of function. Turning the camera on or off while the battery is exhausted can result in reduced battery life.
- Recharge the battery at least once every six months and completely exhaust it before returning it to storage.
- After removing the battery from the camera or optional battery charger, return the battery to the battery case and store in a cool place.
- A marked drop in the time a fully-charged battery retains its charge, when used at room temperature, indicates that the battery needs to be replaced. Purchase a new EN-EL19 battery.
- Replace the battery when it no longer holds a charge. Used batteries are a valuable resource. Please recycle used batteries in accordance with local regulations.

Cleaning

Lens	Avoid touching glass parts with your fingers. Remove dust or lint with a blower (typically a small device with a rubber bulb attached to one end that is pumped to produce a stream of air out the other end). To remove fingerprints or other stains that cannot be removed with a blower, wipe the lens with a soft cloth, using a spiral motion that starts at the center of the lens and working toward the edges. If this fails, clean the lens using a cloth lightly dampened with commercial lens cleaner.
Monitor	Remove dust or lint with a blower. To remove fingerprints and other stains, clean the monitor with a soft, dry cloth, being careful not to apply pressure.
Body	Use a blower to remove dust, dirt or sand, then wipe gently with a soft, dry cloth. After using the camera at the beach or other sandy or dusty environment, wipe off any sand, dust, or salt with a dry cloth lightly dampened with fresh water and dry thoroughly. Note that foreign matter inside the camera could cause damage not covered by the warranty.

Do not use alcohol, thinner, or other volatile chemicals.

Storage

Turn the camera off when not in use. Be sure that the power-on lamp is off before putting the camera away. Remove the battery if the camera will not be used for an extended period. Do not store the camera with naphtha or camphor moth balls, or in any of the following locations:

- Next to equipment that produces strong electromagnetic fields, such as televisions or radios
- Exposed to temperatures below -10°C (14°F) or above 50°C (122°F)
- Places that are poorly ventilated or subject to humidity of over 60%

To prevent mold or mildew, take the camera out of storage at least once a month. Turn the camera on and release the shutter a few times before putting the camera away again.

Notes on the Monitor

- The monitor may contain a few pixels that are always lit or that do not light. This is a characteristic common to all TFT LCD displays, and does not indicate a malfunction. Images recorded using the product will not be affected.
- White or colored streaks may be visible when bright subjects are framed in the monitor. This phenomenon, known as “smear,” occurs when extremely bright light strikes the image sensor; it is characteristic of image sensors and does not indicate a malfunction. Smear may also take the form of partial discoloration in the monitor during shooting. It does not appear in images recorded with the camera except in the cases of movies and of images recorded with **Multi-shot 16** selected for **Continuous**. When shooting in these modes, we recommend that you avoid bright subjects such as the sun, reflected sunlight, and electric lights.
- Images in the monitor may be difficult to see under bright lighting.
- The monitor is lit by an LED backlight. Should the monitor begin to dim or flicker, contact your Nikon-authorized service representative.

Optional Accessories

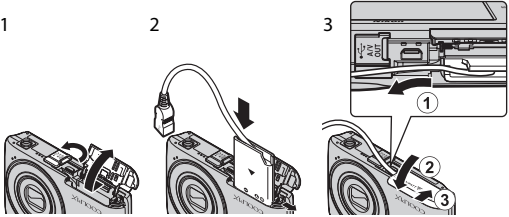
Rechargeable battery	Rechargeable Li-ion Battery EN-EL19 ¹
Charging AC Adapter	Charging AC Adapter EH-69P ^{1,2}
Battery charger	Battery Charger MH-66
AC adapter	<p>AC Adapter EH-62G (connect as shown)</p>  <p>1 2 3</p> <p>Be sure that the power connector cord has been properly aligned in power connector and battery chamber grooves before closing the battery-chamber/memory card slot cover. If part of the cord runs out of the grooves, the cover or cord may be damaged when the cover is closed.</p>
USB cable	USB Cable UC-E6 ¹
Audio/video cable	Audio Video Cable EG-CP14 ¹

1 Supplied with the camera at the time of purchase (→ page 3 of the *Quick Start Guide*).

2 When using in other countries, use a plug adapter (available commercially) as necessary. For more information about plug adapters, consult your travel agency.

Approved Memory Cards

The following Secure Digital (SD) memory cards have been tested and approved for use in this camera.

- Memory cards with an SD Speed Class rating of 6 or faster are recommended for recording movies. Movie recording may stop unexpectedly when memory cards with a lower Speed Class rating are used.

	SD memory card	SDHC memory card ²	SDXC memory card ³
SanDisk	2 GB ¹	4 GB, 8 GB, 16 GB, 32 GB	64 GB
TOSHIBA	2 GB ¹	4 GB, 8 GB, 16 GB, 32 GB	64 GB
Panasonic	2 GB ¹	4 GB, 8 GB, 12 GB, 16 GB, 24 GB, 32 GB	48 GB, 64 GB
Lexar	2 GB ¹	4 GB, 8 GB, 16 GB, 32 GB	–

- If the memory card is used with a card reader or similar device, be sure that the device supports an SD memory card of 2 GB or more.
- SDHC compliant. If the memory card is used with a card reader or similar device, be sure that the device is compliant with the SDHC standard.
- SDXC compliant. If the memory card is used with a card reader or similar device, be sure that the device is compliant with the SDXC.



Contact the manufacturer for details on the above cards.

Image/Sound File and Folder Names



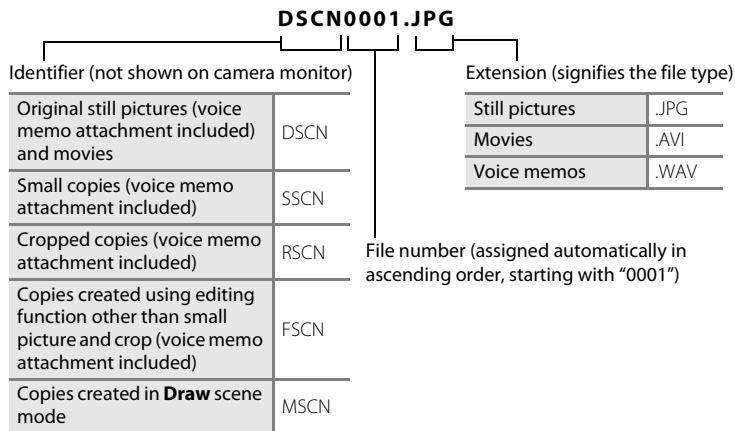







Pictures, movies, or voice memos are assigned file names as follows.













- Files are stored in folders named with a folder number followed by a five-character identifier: "P_" plus a three-digit sequence number for pictures taken using **Panorama assist** scene mode (e.g. "101P_001"; 📖 72) and "NIKON" for all other pictures (e.g. "100NIKON"). When the number of files within a folder reaches 9999, a new folder will be created. File numbers will be assigned automatically starting with "0001."
- Voice memo file names have the same identifier and file number as the picture to which the voice memo is attached.
- Files copied using **Copy>Selected images** are copied to the current folder, where they are assigned new file numbers in ascending order starting from the largest file number in memory. **Copy>All images** copies all folders from the source medium; file names do not change but new folder numbers are assigned in ascending order, starting from the largest folder number on the destination medium (📖 167).
- A single folder can hold up to 200 files; if the current folder already contains 200 files, a new folder, named by adding one to the current folder name, will be created the next time a file is stored. If the current folder is numbered 999 and contains 200 files, or a file is numbered 9999, no further files can be stored until the internal memory or memory card is formatted (📖 159), or a new memory card is inserted.

Error Messages











The following table lists the error messages and other warnings displayed in the monitor, as well as the solutions for dealing with them.







Display	Description	Solution	
 (blinks)	Clock not set.	Set date and time.	149
 Battery exhausted.	Battery exhausted.	Charge or change battery.	16, 18
 Battery temperature high	Battery temperature is high.	Turn off camera, and allow battery to cool down before resuming use. After five seconds, the monitor will turn off, and the power-on lamp will blink rapidly. After the lamps blink for three minutes, the camera will turn off automatically. Pressing the power switch also turns off the camera.	21
 ● (● blinks red)	Camera cannot focus.	<ul style="list-style-type: none"> • Refocus. • Focus on another subject positioned at the same distance from the camera as the intended subject. 	30, 31 52
 Please wait for the camera to finish recording.	Camera cannot perform other operations until recording is complete.	Wait until message clears from display automatically when recording is complete.	–
 Memory card is write protected.	Write-protect switch is in “lock” position.	Slide write-protect switch to “write” position.	25
 This card cannot be used.	Error accessing memory card.	<ul style="list-style-type: none"> • Use approved card. • Check that connectors are clean. • Confirm that memory card is correctly inserted. 	173
 This card cannot be read.			24
 This card cannot be read.			24

Display	Description	Solution	
<p>i Card is not formatted. Format card? Yes No</p>	Memory card has not been formatted for use in COOLPIX S4100.	Formatting deletes all data stored on the memory card. Be sure to tap No and make copies of any pictures which need to be kept before formatting the memory card. Tap Yes to format the memory card.	25
<p>i Out of memory.</p>	Memory card is full.	<ul style="list-style-type: none"> • Choose smaller image size. • Delete pictures. • Insert new memory card. • Remove memory card and use internal memory. 	43 33 24 24
<p>i Image cannot be saved.</p>	Error occurred while recording picture.	Format internal memory or memory card.	159
	Camera has run out of file numbers.	Insert new memory card, or format internal memory or memory card.	174
	Picture cannot be used for welcome screen.	The following pictures cannot be registered as welcome screen. <ul style="list-style-type: none"> • Pictures taken at an Image mode setting of  4224x2376 • Pictures reduced to 320 x 240 size or smaller with cropping or small picture editing 	148
	Insufficient space to save a copy.	Delete pictures from destination.	33
<p>i Album is full. No further pictures can be added.</p>	200 pictures have already been added to album.	<ul style="list-style-type: none"> • Remove some pictures from album. • Add to other albums. 	89 86

Display	Description	Solution	
 Sound file cannot be saved.	A voice memo cannot be attached to this file	<ul style="list-style-type: none"> Voice memos cannot be attached to movies. Select a picture taken with this camera. 	– 108
 A blink was detected in the picture just taken.	One or more portrait subjects may have blinked when the picture was taken.	Check the picture in playback mode.	77, 80
 Image cannot be modified.	Cannot edit selected picture.	<ul style="list-style-type: none"> Select pictures that support editing function. Movies cannot be edited. 	110 –
 Cannot record movie.	Time out error while recording movie.	Choose memory card with faster write speed.	127, 173
 Memory contains no images.	No pictures in the internal memory or memory card.	<ul style="list-style-type: none"> Remove the memory card from the camera to play back pictures stored in the camera's internal memory. To copy picture from internal memory to memory card, display the setup menu and select Copy. 	24 167
	The picture has not been added to album.	<ul style="list-style-type: none"> Add the picture to album. Choose the album to which picture was added. 	86 88
	No pictures are contained in the category selected in auto sort mode.	Select the category containing the sorted pictures.	94
 File contains no image data.	File not created with this camera.	File cannot be viewed on this camera. View file using a computer or the device used to create or edit this file.	–
 This file cannot be played back.			

Error Messages

Display	Description	Solution	
 All images are hidden.	No pictures are available for a slide show.	–	100
 This image cannot be deleted.	Picture is protected.	Disable protection.	101
 Travel destination is in the current time zone.	Destination in same time zone as home.	–	151
 Rating maximum reached. No further pictures can be rated.	999 pictures have already been rated.	Cancel the rating setting of them.	99
 No images with this rating found.	There are no pictures with the selected rating.	<ul style="list-style-type: none"> • Apply the rating to pictures. • Select a rating that has been applied to pictures. 	99 99
 Movies can not be rated.	Ratings cannot be applied to a movie.	Movies cannot be rated. Select still pictures for rating.	99
Lens error 	Lens error.	Turn camera off and then on again. If error persists, contact retailer or Nikon-authorized service representative.	21, 26
 Communications error	Error occurred during communication with printer.	Turn camera off and reconnect cable.	141
System error 	Error has occurred in camera's internal circuitry.	Turn camera off, remove and reinsert battery, and turn camera on. If error persists, contact retailer or Nikon-authorized service representative.	17
 Printer error: check printer status.	Printer error.	Check printer. After solving the problem, tap Resume to resume printing.*	–





Display	Description	Solution	
 Printer error: check paper	Specified size of paper is not loaded in printer.	Load the specified paper, tap Resume to resume printing.*	–
 Printer error: paper jam	Paper has jammed in printer.	Eject the jammed paper, tap Resume to resume printing.*	–
 Printer error: out of paper	No paper is loaded in printer.	Load the specified paper, tap Resume to resume printing.*	–
 Printer error: check ink	Ink error.	Check ink, tap Resume to resume printing.*	–
 Printer error: out of ink	Running out of ink or ink cartridge is empty.	Replace ink cartridge, tap Resume to resume printing.*	–
 Printer error: file corrupt	An error caused by the image file has occurred.	Tap Cancel to cancel printing.	–

* See the documentation provided with your printer for further guidance and information.

Troubleshooting

If the camera fails to function as expected, check the list of common problems below before consulting your retailer or Nikon-authorized service representative.



Display, Settings and Power Supply



Problem	Cause/Solution	
Battery inserted in the camera cannot be charged.	<ul style="list-style-type: none"> • Confirm all connections. • Off is selected for Charge by computer in the setup menu. • When charging by connecting the camera to a computer, battery charging stops when the camera is turned off. • When charging by connecting the camera to a computer, battery charging stops when the computer is suspended (sleeping), and the camera may turn off. • Depending upon computer specifications, settings, and status, charging the battery inserted in the camera may not be possible via computer connection. 	18 161 139 139 –
Camera cannot be turned on.	<ul style="list-style-type: none"> • Battery is exhausted. • The camera cannot be turned on while connected to an electrical outlet via the Charging AC Adapter. 	26 18
Camera turns off without warning.	<ul style="list-style-type: none"> • Battery is exhausted. • Camera has turned off automatically to save power. • The camera and battery may not work properly at low temperatures. • The camera turns off if the Charging AC Adapter is connected while the camera is on. • The camera turns off if the USB cable connecting it to a computer or printer is disconnected. Reconnect the USB cable. 	26 158 170 18 135, 137, 141
Monitor is blank.	<ul style="list-style-type: none"> • Camera is off. • Standby mode for saving power: press the power switch, the shutter-release button,  button,  button, or  button. • When flash lamp blinks, wait until flash has charged. • Camera and computer are connected via USB cable. • Camera and TV are connected via audio/video cable. 	21 21, 158 35 135 132

Electronically Controlled Cameras









In extremely rare instances, unusual characters may appear in the monitor and the camera may stop functioning. In most cases, this phenomenon is caused by a strong external static charge. Turn the camera off, remove and replace the battery, then turn the camera on again. In the event of continued malfunction, contact your retailer or Nikon-authorized service representative. Note that disconnecting the power source as described above may result in the loss of any data not recorded to internal memory or the memory card at the time the problem occurred. Data already recorded will not be affected.

Shooting



Problem	Cause/Solution	
No picture taken when shutter-release button is pressed.	<ul style="list-style-type: none"> When camera is in playback mode, or setting items or setup menu are displayed, press the shutter-release button. Battery is exhausted. When flash lamp blinks, flash is charging. 	32
		26
		35
Camera cannot focus.	<ul style="list-style-type: none"> The subject is too close to the camera. Try shooting with macro mode or in Scene auto selector or Close-up scene mode. The intended subject is one with which autofocus does not perform well. Set AF assist in the setup menu to Auto. Turn camera off and then on again. 	38, 58
		31
		156
		21
Pictures are blurred.	<ul style="list-style-type: none"> Use flash. Increase the ISO sensitivity value. Enable electronic vibration reduction or motion detection. Use BSS (best shot selector). Use tripod and self-timer. 	34
		53
		154, 155
		54
		36
Streaks of light or partial discoloration are visible in the monitor.	Smear occurs when extremely bright light strikes the image sensor. When shooting with Continuous set to Multi-shot 16 and when recording movies, avoiding bright objects, such as the sun, reflections of the sun, and electric lights is recommended.	171
Bright specks appear in pictures taken with flash.	Flash is reflecting off particles in air. Set the flash mode setting to  (off).	35

Problem	Cause/Solution	
Flash does not fire.	<ul style="list-style-type: none"> • The flash mode is set to  (off). • Scene mode with which the flash does not function is selected. • On is selected for Blink proof in smart portrait mode. • Another function that restricts flash is enabled. 	34 59 77 78
Optical zoom cannot be used.	Optical zoom cannot be used while recording movies.	126
Digital zoom cannot be used.	<ul style="list-style-type: none"> • Digital zoom is set to Off in the setup menu. • Digital zoom is not available in the following situations. <ul style="list-style-type: none"> - Subject tracking is selected for the touch shooting setting. - When Scene auto selector, Portrait, Night portrait, or Pet portrait scene mode is selected. - When shooting in smart portrait mode - When Continuous is set to Multi-shot 16. 	156 48 63, 64 74 54
Image mode not available.	Another function that restricts the Image mode option is enabled.	78
No sound when shutter is released.	<ul style="list-style-type: none"> • Off is selected for Sound settings>Shutter sound in setup menu. No sound is heard with some shooting modes and settings, even when On is selected. • The speaker is being blocked. Do not cover the speaker. 	157 5, 28
AF-assist illuminator does not light up.	Off is selected for the AF assist option in the setup menu. AF-assist illuminator may not light up depending on the position of the focus area or the current scene mode, even when Auto is selected.	63-69, 156
Pictures appear smeared.	Lens is dirty. Clean lens.	171
Colors are unnatural.	White balance does not match light source.	55
Randomly spaced bright pixels ("noise") appear in image.	Shutter speed too slow or ISO sensitivity is high as the subject is dark. Noise can be reduced by: <ul style="list-style-type: none"> • Using flash. • Specifying a lower ISO sensitivity setting. 	34 53

Troubleshooting

Problem	Cause/Solution	
Randomly spaced bright pixels (“noise”) appear in movies.	When recording movies in dim lighting, the image may become somewhat “grainy” in appearance. This occurs when the ISO sensitivity increases, and it does not indicate a malfunction.	–
Pictures are too dark (underexposed).	<ul style="list-style-type: none"> • The flash mode is set to  (off) • Flash window is blocked. • Subject is beyond flash range. • Adjust exposure compensation. • Increase ISO sensitivity. • Subject is backlit. Select Backlighting scene mode or set the flash mode setting to  (fill flash). 	34 28 34 39 53 34, 69
Pictures are too bright (overexposed).	Adjust exposure compensation.	39
Unexpected results when flash set to  (auto with red-eye reduction).	When taking pictures with  (auto with red-eye reduction) or fill flash with slow sync and red-eye reduction in Night portrait scene mode, In-Camera Red-Eye Fix may be applied to areas not affected by red-eye. Use any scene mode other than Night portrait , and change the flash mode to any setting other than  (auto with red-eye reduction) and try shooting again.	34, 64
Skin tones are not softened.	<ul style="list-style-type: none"> • Under some shooting conditions, facial skin tones may not be softened. • Select  (skin softening) for Glamour retouch in the retouch menu for pictures containing four or more faces. 	75 121
Saving images takes time.	It may take more time to save images in the following situations. <ul style="list-style-type: none"> • When the noise reduction function is in operation • When flash mode is set to  (auto with red-eye reduction) • When the skin softening function is applied while shooting 	35 35 63, 64, 77

Playback

Problem	Cause/Solution	
File cannot be played back.	<ul style="list-style-type: none"> • File or folder was overwritten or renamed by computer or other make of camera. • The COOLPIX S4100 is not able to playback movies recorded with another make or model of digital camera. 	– 131
Cannot zoom in on picture.	<ul style="list-style-type: none"> • Pictures taken with cameras other than COOLPIX S4100 may not be enlarged. • Playback zoom cannot be used with movies, small pictures, or pictures that have been cropped to a size of 320 × 240 or smaller. 	–
Cannot record or play back voice memos.	<ul style="list-style-type: none"> • Voice memos cannot be attached to movies. • Voice memos cannot be attached to images taken with other cameras. Voice memos attached to images using another camera cannot be played back on this camera. 	131 109
Cannot edit pictures.	<ul style="list-style-type: none"> • These options cannot be used with movies. • These options cannot be used with pictures taken at an Image mode setting of  4224×2376. • Select pictures that support editing functions. • Camera is unable to edit pictures taken with other cameras. 	131 43 110 110
Pictures not displayed on television.	<ul style="list-style-type: none"> • Choose correct Video mode. • Memory card contains no pictures. Replace the memory card. Remove the memory card to play back pictures from the internal memory. • TV display is turned off and pictures are displayed in the camera monitor. 	160 24 133
Album icon restored to default settings, or pictures added to album not displayed in favorite pictures mode.	Data on the memory card may not be played back correctly if overwritten by a computer.	–

Problem	Cause/Solution	
<p>The recorded pictures are not displayed in auto sort mode.</p>	<ul style="list-style-type: none"> • The desired picture was sorted to a category other than the category currently displayed. • Pictures recorded by a camera other than the COOLPIX S4100 and pictures copied using the Copy option cannot be displayed in auto sort mode. • Pictures recorded in the internal memory or on the memory card may not be played back correctly if overwritten by a computer. • Up to 999 pictures and movies in total can be added to each category. If the desired category already contains 999 pictures or movies in total, new pictures or movies cannot be added. 	<p>93 167 – 94</p>
<p>Nikon Transfer 2 does not start when camera is connected.</p>	<ul style="list-style-type: none"> • Camera is off. • Battery is exhausted. • USB cable is not correctly connected. • Camera is not recognized by the computer. • Confirm system requirements. • Computer is not set to start Nikon Transfer 2 automatically. For more information on Nikon Transfer 2, refer to help information contained in ViewNX 2. 	<p>21 26 135 – 134 138</p>
<p>The PictBridge startup screen is not displayed when the camera is connected to a printer.</p>	<p>With some PictBridge-compatible printers, the PictBridge startup screen may not be displayed and it may be impossible to print pictures when Auto is selected for the Charge by computer option in the setup menu. Set the Charge by computer option to Off and reconnect the camera to the printer.</p>	<p>161</p>
<p>Pictures to be printed are not displayed.</p>	<ul style="list-style-type: none"> • Memory card contains no pictures. Replace the memory card. • Remove the memory card to print pictures from the internal memory. 	<p>24 24</p>
<p>Cannot select paper size with camera.</p>	<p>Paper size cannot be selected from the camera in the following situations, even when printing from a PictBridge-compatible printer:</p> <ul style="list-style-type: none"> • The printer does not support the paper size specified by the camera. • The printer automatically selects the paper size. 	<p>142, 143 –</p>

Specifications

Nikon COOLPIX S4100 Digital Camera

Type	Compact digital camera
Effective pixels	14.0 million
Image sensor	¹ /2.3-in. type CCD; total pixels: approx. 14.48 million
Lens	5x optical zoom, NIKKOR lens
Focal length	4.6–23.0mm (angle of view equivalent to that of 26–130 mm lens in 35mm [135] format)
f/-number	f/3.2–6.5
Construction	6 elements in 5 groups
Digital zoom	Up to 4x (angle of view equivalent to that of approx. 520 mm lens in 35mm [135] format)
Vibration reduction	Electronic VR
Autofocus (AF)	Contrast-detect AF
Focus range (from lens)	<ul style="list-style-type: none">• Approx. 50 cm (1 ft. 8 in.) to ∞ (W); approx. 80 cm (2 ft. 8 in.) to ∞ (T)• Macro mode: Approx. 10 cm (4 in.) (wide-angle position) to ∞
Focus-area selection	Face priority, auto (9-area automatic selection), center, manual (focus area can be selected using the touch panel), subject tracking
Monitor	7.5 cm (3-in.), approx. 460k-dot, TFT LCD (touch panel) and 5-level brightness adjustment
Frame coverage (shooting mode)	Approx. 97% horizontal and 97% vertical (compared to actual picture)
Frame coverage (playback mode)	Approx. 100% horizontal and 100% vertical (compared to actual picture)
Storage	
Media	<ul style="list-style-type: none">• Internal memory (approx. 20 MB)• SD/SDHC/SDXC memory card
File system	DCF, Exif 2.3, and DPOF compliant
File formats	Still pictures: JPEG Sound files (Voice Memo): WAV Movies: AVI (Motion-JPEG compliant)
Image size (pixels)	<ul style="list-style-type: none">• 14M (High image quality) [4320 × 3240★]• 14M [4320 × 3240]• 8M [3264 × 2448]• 5M [2592 × 1944]• 3M [2048 × 1536]• PC [1024 × 768]• VGA [640 × 480]• 16:9 [4224 × 2376]

Specifications

ISO sensitivity (Standard output sensitivity)	<ul style="list-style-type: none"> • ISO 80, 100, 200, 400, 800, 1600, 3200 • Auto (auto gain from ISO 80 to 1600) • Fixed range auto (ISO 80 to 400, 80 to 800)
Exposure	
Metering	256-segment matrix, center-weighted (digital zoom less than 2x), spot (digital zoom 2x or more)
Exposure control	Programmed auto exposure with motion detection and exposure compensation (-2.0 to +2.0 EV in steps of 1/3 EV)
Shutter	Mechanical and charge-coupled electronic shutter
Speed	1/2000–1 s 4 s (when scene mode is set to Fireworks show)
Aperture	Electronically-controlled ND filter (-2.6 AV) selection
Range	2 steps (f/3.2 and f/8 [W])
Self-timer	Can be selected from 10 and 2 second duration
Built-in flash	
Range (approx.) (ISO sensitivity: Auto)	[W]: 0.5 to 4.5 m (1 ft. 8 in. to 14 ft.) [T]: 0.5 to 2.2 m (1 ft. 8 in. to 7 ft. 3 in.)
Flash control	TTL auto flash with monitor preflashes
Interface	Hi-Speed USB
Data Transfer Protocol	MTP, PTP
Video output	Can be selected from NTSC and PAL
I/O terminal	Audio video output/digital I/O (USB)
Supported languages	Arabic, Chinese (Simplified and Traditional), Czech, Danish, Dutch, English, Finnish, French, Greek, German, Hungarian, Indonesian, Italian, Japanese, Korean, Polish, Portuguese, Norwegian, Romanian, Russian, Spanish, Swedish, Thai, Turkish, Ukrainian
Power sources	One Rechargeable Li-ion Battery EN-EL19 (supplied) AC Adapter EH-62G (available separately)
Charging time	Approx. 2 hours and 10 minutes (when using Charging AC Adapter EH-69P and when no charge remains)
Battery life (EN-EL19)	Still pictures*: Approx. 190 shots Movies: Approx. 1 h 30 min (HD 720p (1280x720))
Tripod socket	1/4 (ISO 1222)
Dimensions (W x H x D)	Approx. 95.0 x 56.8 x 19.9 mm (3.8 x 2.3 x 0.8 in.) (excluding projections)

Weight	Approx. 131 g (4.7 oz.) (with battery and SD memory card)
---------------	---

Operating environment	
------------------------------	--

Temperature	0°C to 40°C (32°F to 104°F)
--------------------	-----------------------------

Humidity	Less than 85% (no condensation)
-----------------	---------------------------------

- Unless otherwise stated, all figures are for a camera with a fully-charged Rechargeable Li-ion Battery EN-EL19 operated at an ambient temperature of 25°C (77°F).

* Based on Camera and Imaging Products Association (CIPA) standards for measuring the life of camera batteries. Measured at 23 (±2) °C (73 (±4) °F); zoom adjusted with each shot, flash fired with every other shot, image mode set to  4320×3240. Battery life may vary depending on shooting interval and length of time menus and images are displayed.

Rechargeable Li-ion Battery EN-EL19

Type	Rechargeable lithium-ion battery
Rated capacity	DC 3.7 V, 700 mAh
Operating temperature	0°C to 40°C (32°F to 104°F)
Dimensions (W × H × D)	Approx. 31.5 × 39.5 × 6 mm (1.3 × 1.6 × 0.3 in.) (excluding projections)
Weight	Approx. 14 g (0.5 oz.) (excluding battery case)

Charging AC Adapter EH-69P

Rated input	AC 100–240 V, 50/60 Hz, 0.068–0.042 A
Rated capacity	6.8–10.1 VA
Rated output	DC 5.0 V, 550 mA
Operating temperature	0°C to 40°C (32°F to 104°F)
Dimensions (W × H × D)	Approx. 55 × 22 × 54 mm (2.2 × 0.9 × 2.2 in.) (excluding plug adapter) For Argentina: Approx. 55 × 59 × 63 mm (2.2 × 2.4 × 2.5 in.)
Weight	Approx. 55 g (2.0 oz.) (excluding plug adapter) For Argentina: Approx. 80 g (2.9 oz.)

Specifications

















Nikon will not be held liable for any errors this manual may contain. The appearance of this product and its specifications are subject to change without notice.





Supported Standards

- **DCF:** Design Rule for Camera File System is a standard widely used in the digital camera industry to ensure compatibility among different makes of camera.
- **DPOF:** Digital Print Order Format is an industry-wide standard that allows pictures to be printed from print orders stored on memory card.
- **Exif version 2.3:** This camera supports Exchangeable image file format (Exif) version 2.3 for digital still cameras, a standard that allows information stored with photographs to be used for optimal color reproduction when images are output from Exif-compliant printers.
- **PictBridge:** A standard developed cooperatively by the digital camera and printer industries, allowing photographs to be output directly to a printer without connecting the camera to a computer.

Index

Symbols

-  Auto mode 26
-  Scene mode 58
-  Smart portrait mode 74
-  Playback mode 32
-  Favorite pictures mode 86
-  Auto sort mode 93
-  List by date mode 96
-  Setup menu 146
- T** (Telephoto) 4
- W** (Wide-angle) 4
-  Playback zoom 4, 83
-  Thumbnail playback 4, 81
-  Shooting mode button 5, 6
-  Playback button 5, 6, 32
-  (movie-record) button 5, 6
-  Exit icon 14
-  Return icon 14
- AE/AF-L** 73
- A**
 - AC adapter 172
 - AF area 30
 - AF assist 156
 - Album 88
 - adding pictures to 86
 - removing pictures from 89
 - Aperture 30
 - Audio/video cable 132, 172
 - Audio/video-in jack 132
 - Auto flash 34
 - Auto mode 26
 - Auto off 158
 - Auto sort mode 93
 - Autofocus 38
 - AVI 174
- B**
 - Back light  69
 - Battery 16, 18, 150
 - Battery charger 20, 172
 - Battery latch 5, 16

- Battery level indicator 26
- Battery-chamber 5
- Battery-chamber/memory card slot cover 5, 16, 24
- Beach  65
- Best Shot Selector 54
- Black and white copy  68
- Blink proof 77
- Blink warning 162
- Brightness 152
- BSS 54
- Built-in microphone 4, 108
- Button sound 157
- C**
 - Charge by computer 161
 - Charge lamp 19, 139
 - Charger 18
 - Charging AC Adapter 18
 - Close-up  67
 - Cloudy 55
 - Compression ratio 43
 - Computer 134
 - copying pictures to 134–138
 - Connector cover 5
 - Continuous 54
 - Copying pictures 167
 - Crop 124
- D**
 - Daylight 55
 - Daylight saving time 22, 150
 - Delete 33, 109
 - Digital zoom 29, 156
 - Direct print 140
 - D-Lighting 110, 116
 - DPOF 190
 - DPOF print 145
 - Drag 8
 - Drag and drop 8
 - Draw  69, 71
 - DSCN 174

Dusk/dawn  66

E

EH-69P 18

Electronic VR 154

EN-EL19 16, 18

Exposure compensation 39

Extension 174

Eyelet for camera strap 4

F

Face detection 28, 41

Favorite pictures mode 90

File names 174

Fill flash 34

Filter effects 119

Fireworks show  68

Firmware version 168

Fixed range auto 53

Flash 4, 34, 35

Flash lamp 5, 35

Flash mode 34

Flash off 34

Fluorescent 55

Focus 7, 30

Folder name 174

Food  67

Format 25, 159

Format memory card 25, 159

Formatting internal memory 159

FSCN 174

Full-frame playback 80

Full-time AF 129

G

Glamour retouch 121

H

Halfway 7

HD 720p 128

Help 58

I

Identifier 174

Image mode 43

Image review 152

Image size 43

Incandescent 55

Internal memory 24

Internal memory indicator 27

ISO sensitivity 53

J

JPG 174

L

Landscape  63

Language 160

Lens 4, 187

Lens cover 4

List by date mode 96

M

Macro mode 38

Memory card 24, 173

Memory card slot 5, 24

Monitor 5, 10, 171

Monitor settings 152

Motion detection 155

Movie AF mode 129

Movie length 129

Movie options 128

Movie playback 131

Movie recording 126

Movie-record button 6

Multi-shot 16 54

Museum  68

N

Night landscape  66

Night portrait  64

Nikon Transfer 2 134, 135

Number of exposures remaining 26, 44

O



Optional accessories 172

P

Paint 112

Panorama assist  69, 72

Panorama Maker 5 134, 138

Paper size 142, 143
 Party/indoor  65
 Perspective control 118
 Pet portrait  70
 PictBridge 140, 190
 Playback 32, 80, 81, 83, 109, 131, 152
 Playback mode 85
 Portrait  63
 Power 21, 22, 26
 Power switch/power-on lamp 4, 21, 26
 Preset manual 56
 Press halfway 7
 Print 142, 143
 Print date 106, 153
 Print order 103
 Printer 140

Q



Quick retouch 115
 QVGA 128, 129

R

Rating 99
 Rechargeable battery 172
 Rechargeable Li-ion battery 16, 18
 Recording movies 126
 Red-eye reduction 34, 35
 Reset all 164
 Rotate image 107
 RSCN 174

S

Scene auto selector  61
 Scene mode 58, 63
 Self-timer 36
 Self-timer lamp 4, 37
 Setup menu 146
 Shooting 26, 28, 30, 152
 Shooting mode 40
 Shutter speed 157
 Shutter speed 30
 Shutter-release button 4, 30
 Single 54

Single AF 129
 Skin softening 77
 Slide show 100
 Slow Sync 34
 Small picture 123
 Smart portrait mode 74
 Smile timer 77
 Snow  65
 Sound settings 157
 Speaker 5
 Sports  64
 SSCN 174
 Strap 7
 Stretch 117
 Stylus 9
 Subject tracking 48
 Sunset  66

T

Tap 8
 Thumbnail playback 81
 Time zone 22, 149, 151
 Time zone and date 22, 149
 Touch AF/AE 50
 Touch shooting 42
 Touch shutter 45
 Tripod socket 5
 TV 132

U

USB cable 135, 141
 USB/audio/video output connector 5,
 132, 135, 141

V

VGA 128, 129
 Video mode 133, 160
 ViewNX 2 134, 138
 Voice memo 108
 Volume 109, 131

W

WAV 174
 Welcome screen 148

Index

White balance 55

Wind noise reduction 130

Z

Zoom 29

Zoom control 4, 29

Nikon

No reproduction in any form of this manual, in whole or in part (except for brief quotation in critical articles or reviews), may be made without written authorization from NIKON CORPORATION.



NIKON CORPORATION

© 2011 Nikon Corporation

YP1A02(11)
6MM01011-02